

AERO EXTRACTOR-INYECTOR TUBO AXIAL ATC ALTA EFICIENCIA EN ACOPLAMIENTO DIRECTO ALABES AJUSTABLES DE 24", 30", 36", 42" DE DIÁMETRO



La serie XDP/A de Aero Extractores – Inyectores tubo axiales marca ATC en acoplamiento directo ha sido especialmente diseñada para aplicaciones Industriales en conductos, disponibles en 36 modelos distintos con 4 diámetros de hélice de alabes en ángulo variable estandarizadas de 24", 30", 36" y 42" brindando caudales desde 9,000 hasta 52,000 m³/hr.

Características principales:

- Carcaza tubular y bridas fabricadas en acero al carbón con acabado en pintura poliéster en polvo homeada.
- Hélice de aluminio inyectado ó polipropileno reforzado con fibra de vidrio de 7 alabes en ángulo variable balanceada dinámicamente, anti-chispa, altamente resistente a la corrosión.
- Accionado por acoplamiento directo a los motores eléctricos trifásicos de eficiencia premium en 4, 6 y 8 polos, diseñados bajo las especificaciones NEMA.

Aplicaciones:

Proyección directa y localizada de aire en procesos industriales, presurización en conductos, torres de enfriamiento, extracción de humo, gases en estacionamientos, túneles, etc.

NOMENCLATURA: $\frac{XD}{1} \frac{P/A}{2} - \frac{6}{3} - \frac{42}{4} / \frac{30}{5}^{\circ}$

1. Modelo
2. Tipo de Hélice
P: Plástico
A: Aluminio
3. No de Polos del motor
4. Diámetro de hélice en pulgadas
5. Grado de inclinación de los alabes

ESPECIFICACIONES TÉCNICAS (PERFORMANCE DATA)

| MODELO (MODEL) | CAUDAL@ DESCARGA LIBRE | | AMPERAJE (A) @ 60HZ. 3 FASES | | POTENCIA (HP) | RPM | NIVEL SONORO dB (A)* | PESO APROX. | |
|------------------|------------------------|--------------------|------------------------------|------|---------------|------|----------------------|-------------|-----|
| | CFM | M ³ /HR | 220V | 440V | | | | Lb. | Kg. |
| XDP/A-4-24/20° | 6,350 | 10,789 | 5.2 | 2.6 | 1.5 | 1760 | 64 | 64 | 29 |
| XDP/A-4-24/25° | 7,970 | 13,541 | 6.6 | 3.3 | 2.0 | 1760 | 69 | 66 | 30 |
| XDP/A-4-24/32.5° | 10,500 | 17,840 | 9.8 | 4.9 | 3.0 | 1760 | 75 | 101 | 46 |
| XDP/A-4-24/40° | 12,800 | 21,747 | 15.0 | 7.5 | 5.0 | 1760 | 79 | 106 | 48 |
| XDP/A-6-24/25° | 5,250 | 8,920 | 2.4 | 1.2 | 1/2 | 1160 | 60 | 46 | 21 |
| XDP/A-6-24/30° | 6,360 | 10,806 | 2.8 | 1.4 | 3/4 | 1160 | 64 | 53 | 24 |
| XDP/A-6-24/35° | 7,500 | 12,743 | 3.8 | 1.9 | 1.0 | 1160 | 67 | 57 | 26 |
| XDP/A-6-24/40° | 8,440 | 14,340 | 4.8 | 2.4 | 1.5 | 1160 | 70 | 90 | 41 |
| XDP/A-6-24/45° | 9,200 | 15,631 | 6.2 | 3.1 | 2.0 | 1160 | 72 | 92 | 42 |
| XDP/A-4-30/20° | 10,500 | 17,840 | 6.6 | 3.3 | 2 | 1760 | 73 | 90 | 41 |
| XDP/A-4-30/25° | 13,600 | 23,106 | 9.8 | 4.9 | 3 | 1760 | 78 | 126 | 57 |
| XDP/A-4-30/30° | 16,700 | 28,373 | 15.0 | 7.5 | 5 | 1760 | 83 | 130 | 59 |
| XDP/A-4-30/32.5° | 18,400 | 31,262 | 15.0 | 7.5 | 5 | 1760 | 85 | 130 | 59 |
| XDP/A-6-30/20° | 6,900 | 11,723 | 2.8 | 1.4 | 3/4 | 1160 | 64 | 77 | 35 |
| XDP/A-6-30/25° | 8,950 | 15,206 | 3.8 | 1.9 | 1 | 1160 | 69 | 82 | 37 |
| XDP/A-6-30/32.5° | 12,100 | 20,558 | 6.2 | 3.1 | 2 | 1160 | 76 | 117 | 53 |
| XDP/A-6-30/40° | 15,200 | 25,825 | 8.4 | 4.2 | 3 | 1160 | 81 | 148 | 67 |

* Nivel Sonoro medido a 1.50 mts. (5 pies) de la fuente en un campo hemisférico libre según AMCA standard 301.

XDP/A

AERO EXTRACTOR – INYECTOR TUBO AXIAL ATC

ALTA EFICIENCIA EN ACOPLAMIENTO DIRECTO
ALABES AJUSTABLES DE 24", 30", 36", 42" DE DIÁMETRO

ESPECIFICACIONES TÉCNICAS (PERFORMANCE DATA)

| MODELO (MODEL) | CAUDAL@ DESCARGA LIBRE | | AMPERAJE (A)@ 60 HZ. 3 FASES | | POTENCIA (HP) | RPM | NIVEL SONORO dB (A)* | PESO APROX. | |
|-------------------|---------------------------|--------------------|---------------------------------|------|------------------|------|----------------------------|-------------|-----|
| | CFM | M ³ /HR | 220V | 440V | | | | Lb. | Kg. |
| | | | | | | | | | |
| XDP/A-4-36/25° | 18,300 | 31,092 | 15.0 | 7.5 | 5.0 | 1760 | 73 | 145 | 66 |
| XDP/A-4-36/30° | 23,600 | 40,096 | 23.0 | 11.5 | 7.5 | 1760 | 78 | 176 | 80 |
| XDP/A-6-36/25° | 12,100 | 20,558 | 4.8 | 2.4 | 1.5 | 1160 | 64 | 117 | 53 |
| XDP/A-6-36/30° | 15,500 | 26,335 | 6.2 | 3.1 | 2.0 | 1160 | 69 | 119 | 54 |
| XDP/A-6-36/35° | 19,300 | 32,791 | 8.4 | 4.2 | 3.0 | 1160 | 74 | 150 | 68 |
| XDP/A-6-36/40° | 22,600 | 38,397 | 14.2 | 7.1 | 5.0 | 1160 | 77 | 202 | 92 |
| XDP/A-8-36/30° | 11,500 | 19,539 | 4.0 | 2.0 | 1.0 | 860 | 63 | 134 | 61 |
| XDP/A-8-36/35° | 14,300 | 24,296 | 5.4 | 2.7 | 1.5 | 860 | 67 | 150 | 68 |
| XDP/A-8-36/40° | 16,800 | 28,543 | 7.0 | 3.5 | 2.0 | 860 | 71 | 180 | 82 |
| XDP/A-8-36/45° | 19,500 | 33,131 | 9.8 | 4.9 | 3.0 | 860 | 74 | 191 | 87 |
| XDP/A-4-42/25° | 25,100 | 42,645 | 23.0 | 11.5 | 7.5 | 1760 | 80 | 207 | 94 |
| XDP/A-6-42/30° | 22,000 | 37,378 | 8.4 | 4.2 | 3 | 1160 | 77 | 181 | 82 |
| XDP/A-6-42/32.5° | 25,000 | 42,475 | 14.2 | 7.1 | 5 | 1160 | 80 | 234 | 106 |
| XDP/A-6-42/35° | 28,100 | 47,742 | 14.2 | 7.1 | 5 | 1160 | 82 | 234 | 106 |
| XDP/A-6-42/37.5° | 30,500 | 51,820 | 20.0 | 10.0 | 7.5 | 1160 | 84 | 331 | 150 |
| XDP/A-8-42/25° | 12,300 | 20,898 | 4.0 | 2.0 | 1 | 860 | 65 | 165 | 75 |
| XDP/A-8-42/30° | 16,300 | 27,694 | 5.4 | 2.7 | 1.5 | 860 | 71 | 181 | 82 |
| XDP/A-8-42/32.5° | 18,600 | 31,601 | 7.0 | 3.5 | 2 | 860 | 73 | 212 | 96 |
| XDP/A-8-42/35° | 20,800 | 35,339 | 9.8 | 4.9 | 3 | 860 | 76 | 223 | 101 |

* Nivel Sonoro medido a 1.50 mts. (5 pies) de la fuente en un campo hemisférico libre según AMCA standard 301.

VISTA FRONTAL (FRONT VIEW)

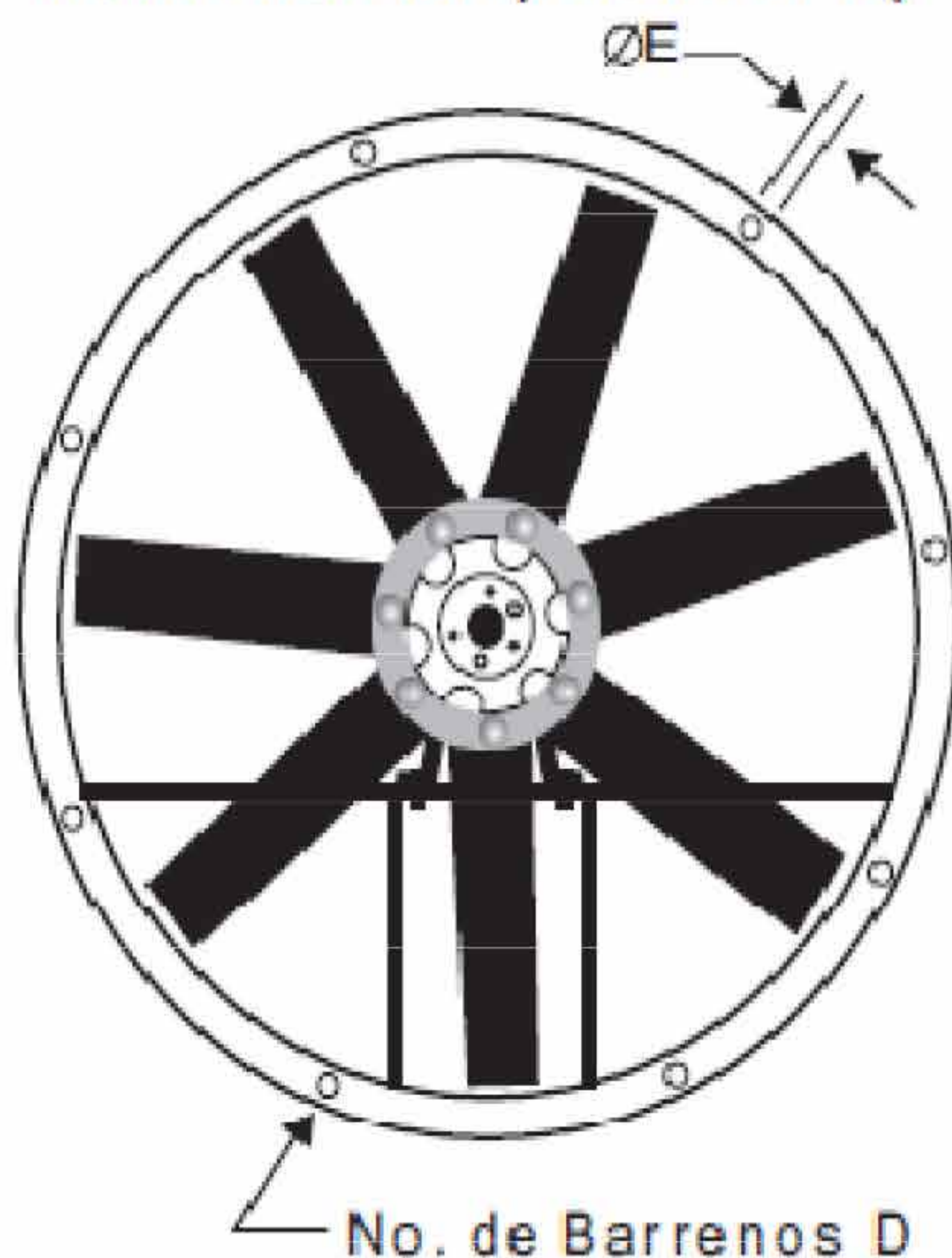

VISTA LATERAL (SIDE VIEW)

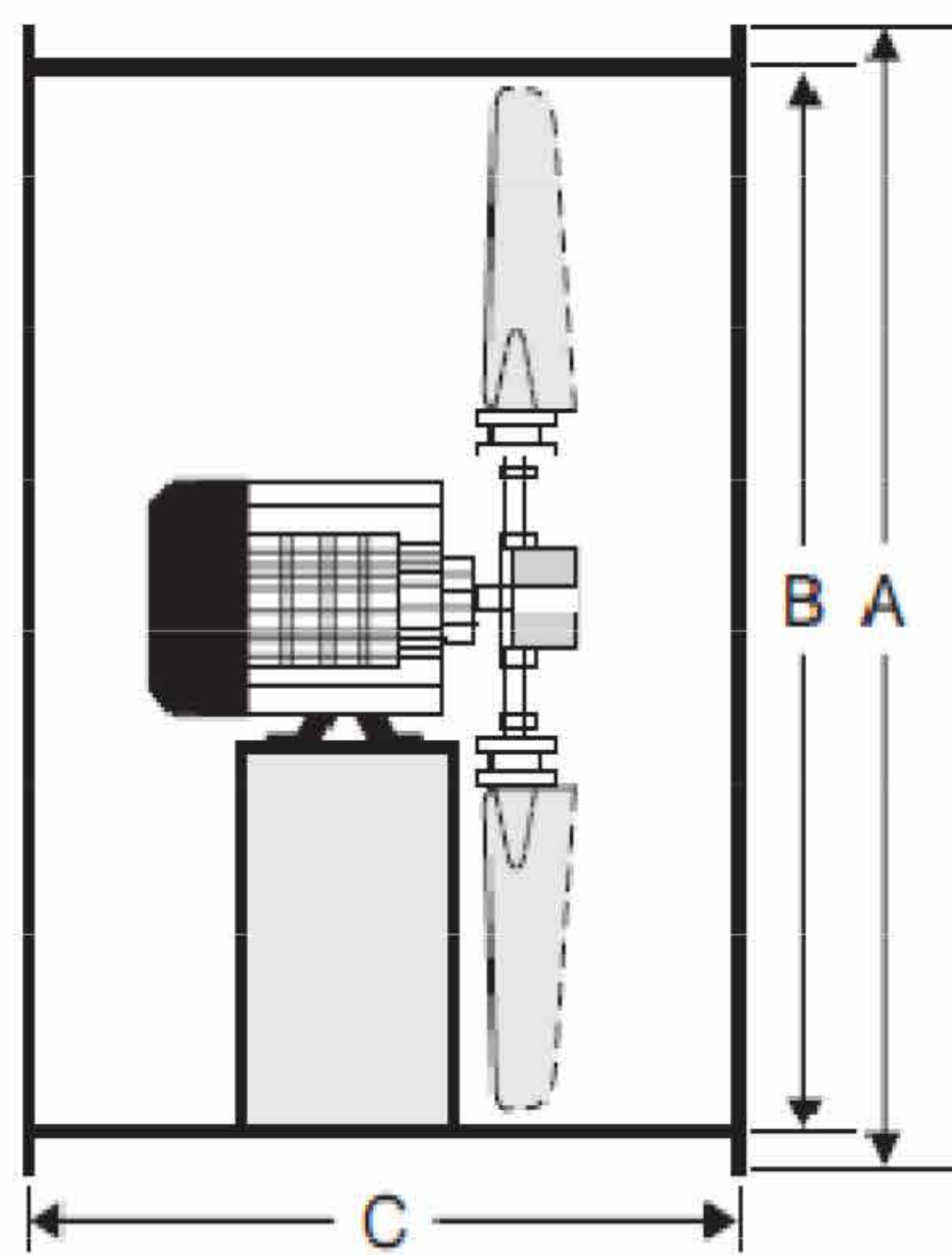

DIMENSIONES GENERALES (Dimensions)

| MODELO (MODEL) | Pulgadas (Inches) | | | | |
|-------------------|-------------------|----|----|---|-----|
| | A | B | C | D | Ø E |
| XDP/A-24 | 28 | 25 | 19 | 8 | 1/2 |
| XDP/A-30 | 35 | 31 | 19 | 8 | 1/2 |
| XDP/A-36 | 41 | 37 | 24 | 8 | 1/2 |
| XDP/A-42 | 47 | 43 | 24 | 8 | 1/2 |

ACCESORIOS OPCIONALES:

Rejillas de protección electrosoldadas
en la succión y/o descarga.

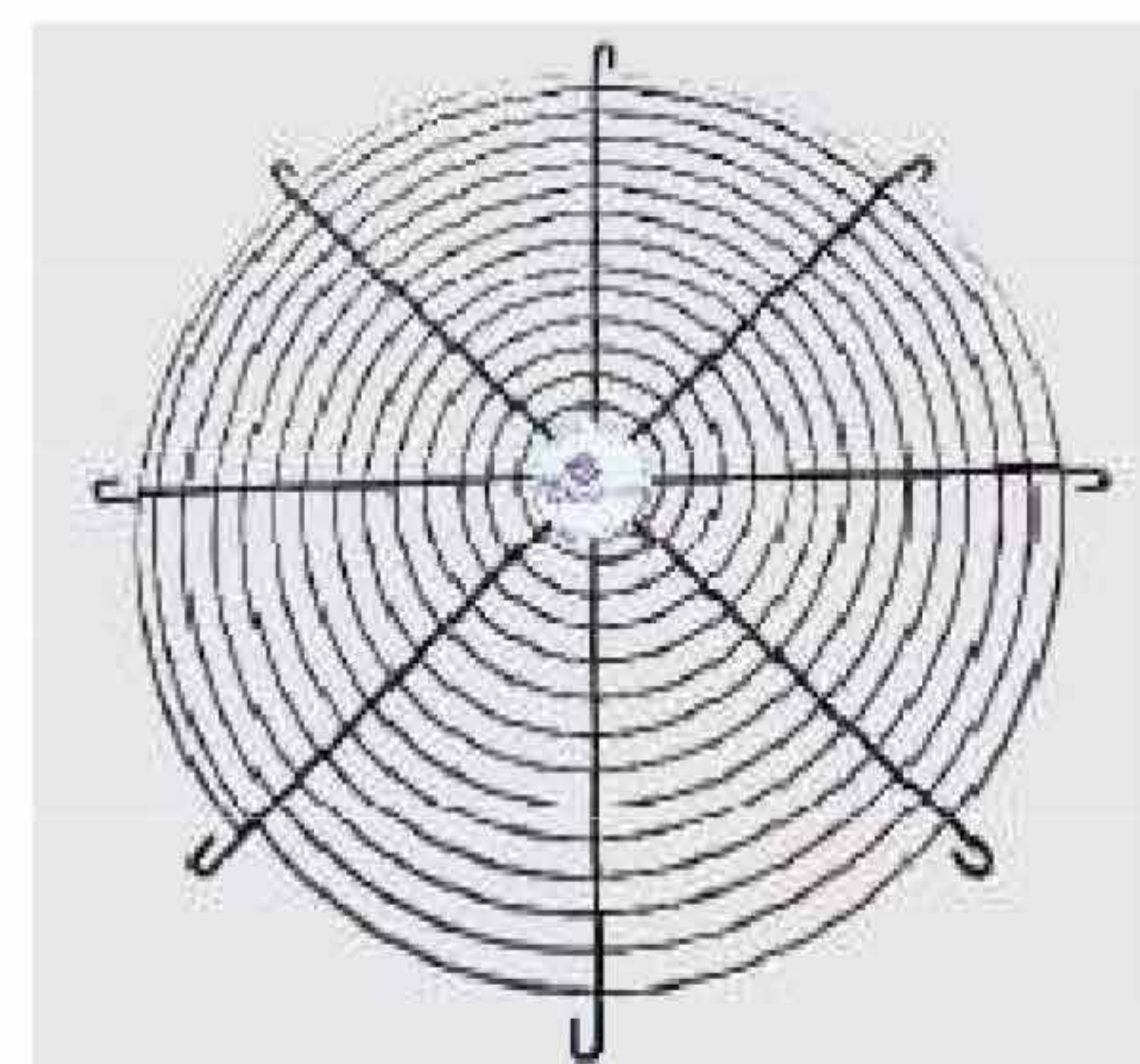

XDP/A

AERO EXTRACTOR – INYECTOR TUBO AXIAL ATC

ALTA EFICIENCIA EN ACOPLAMIENTO DIRECTO
ALABES AJUSTABLES DE 24", 30", 36", 42" DE DIÁMETRO

CURVAS DE OPERACIÓN (PERFORMANCE CURVES)

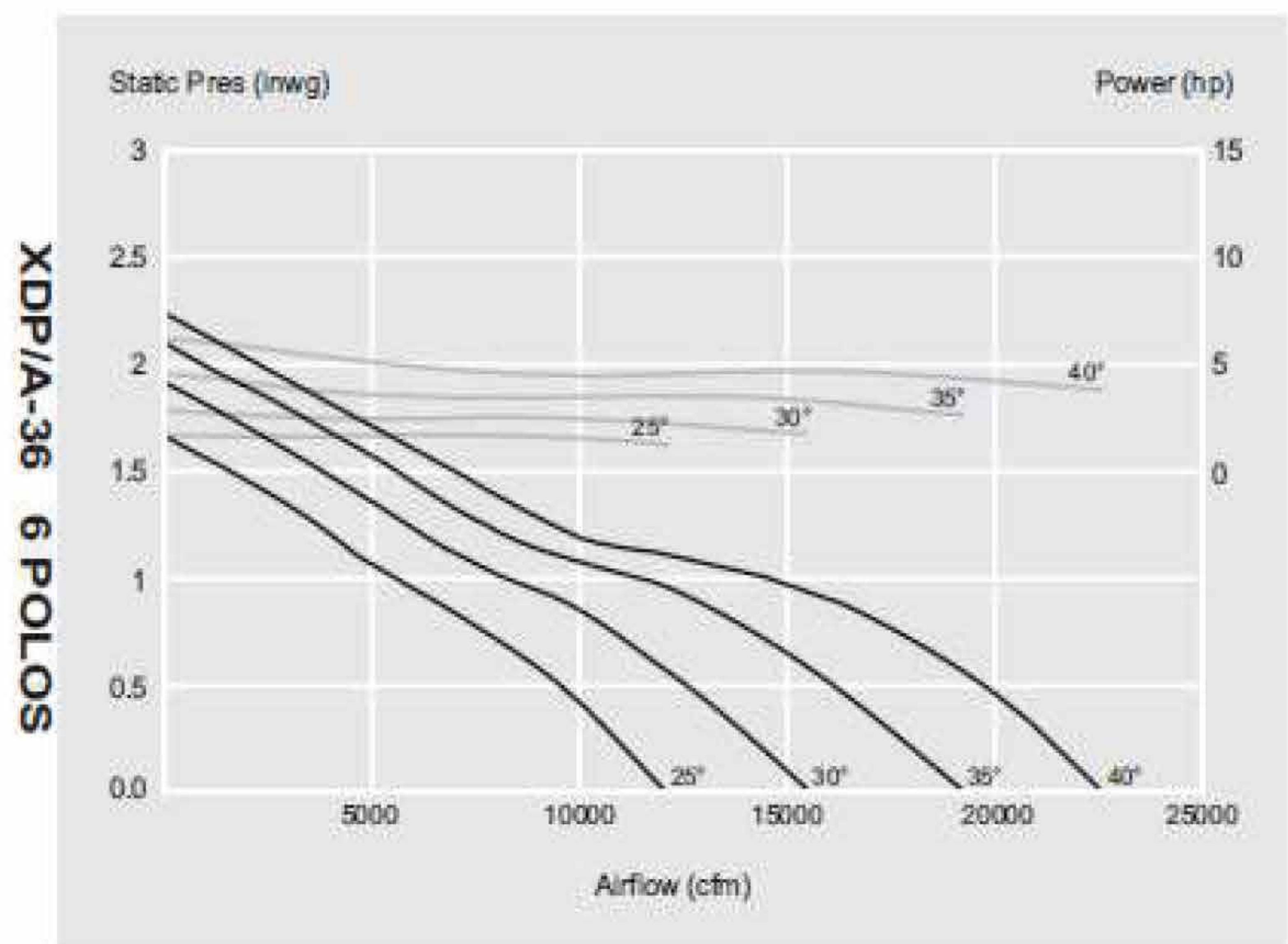
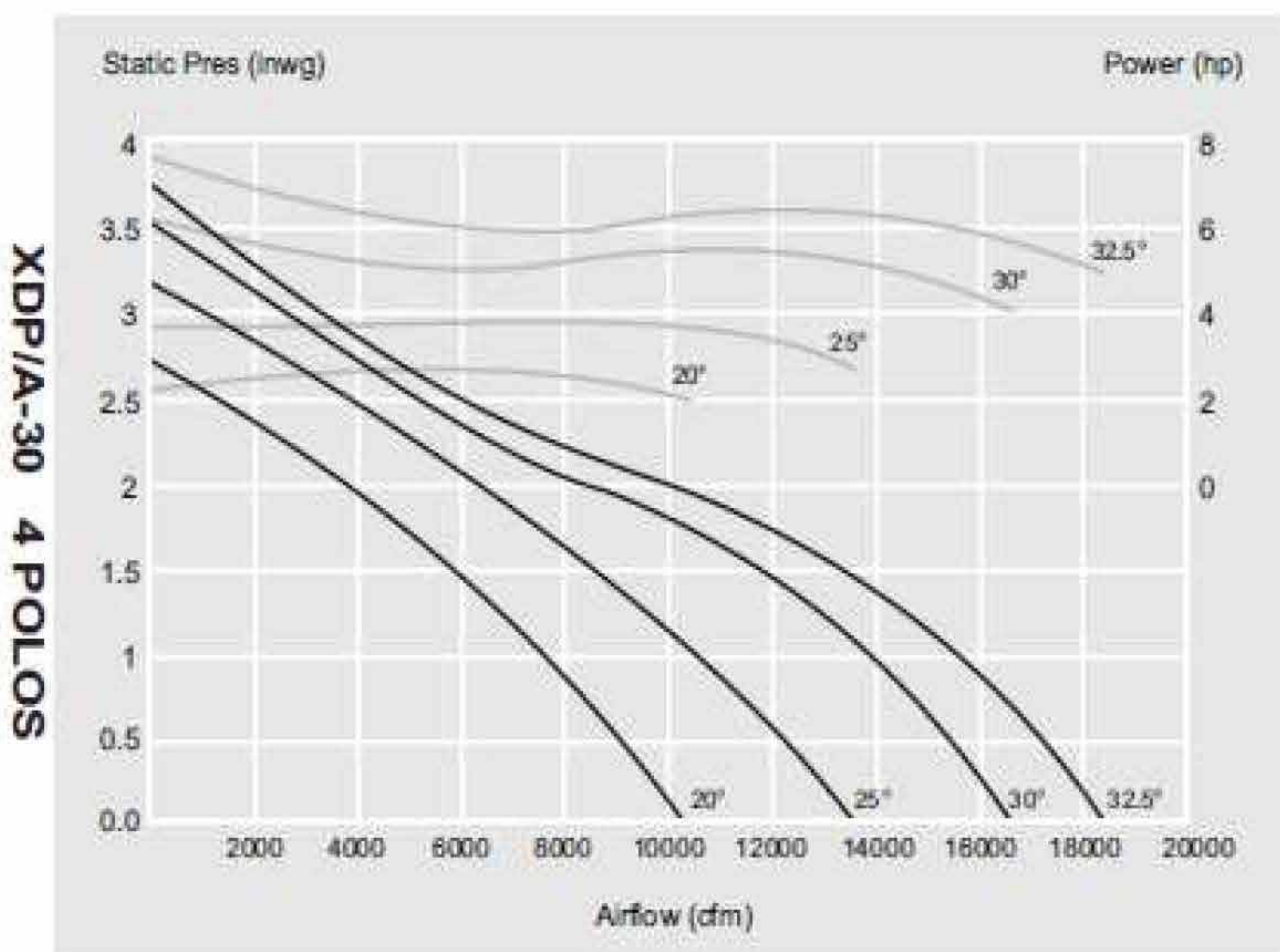
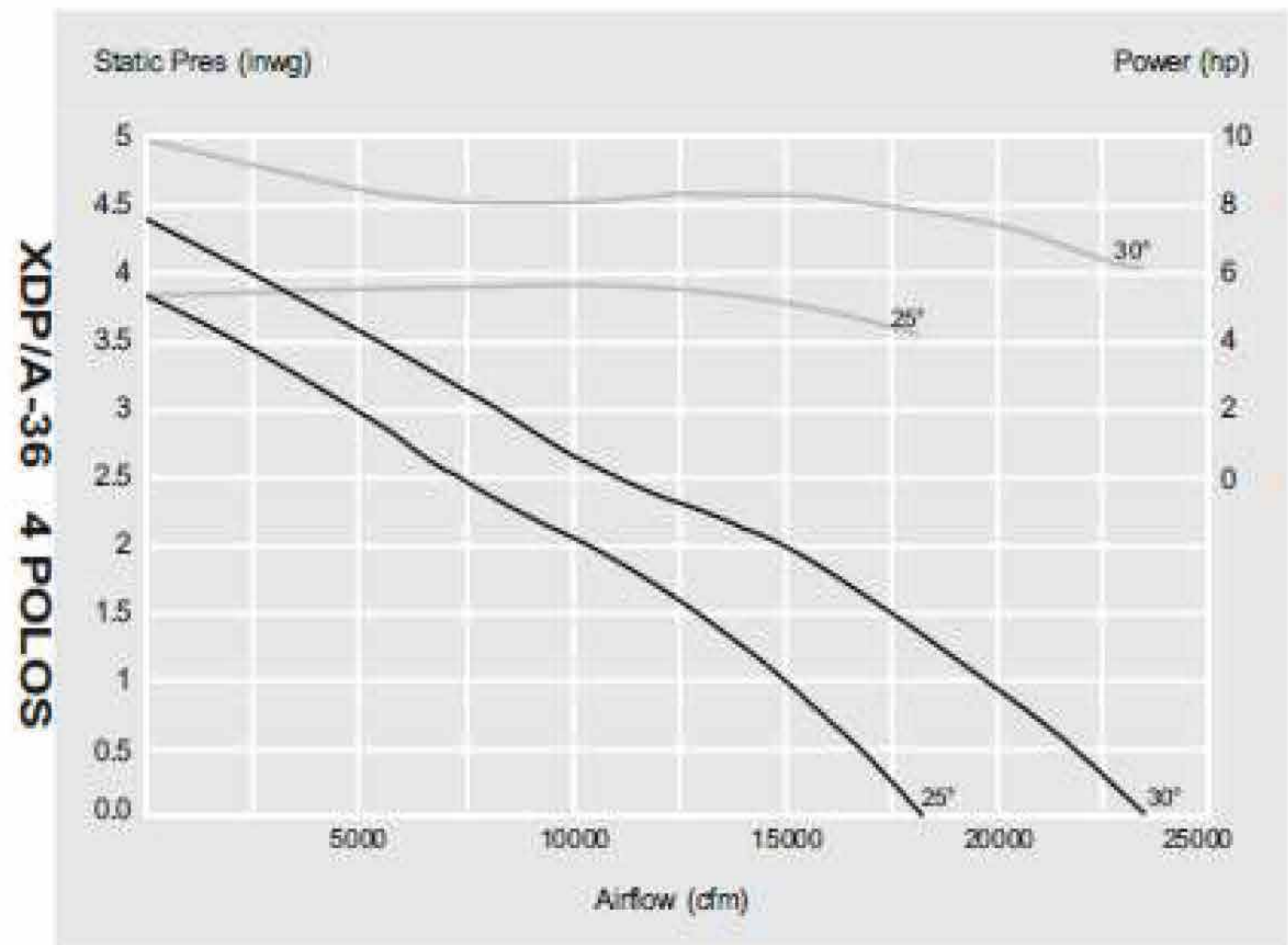
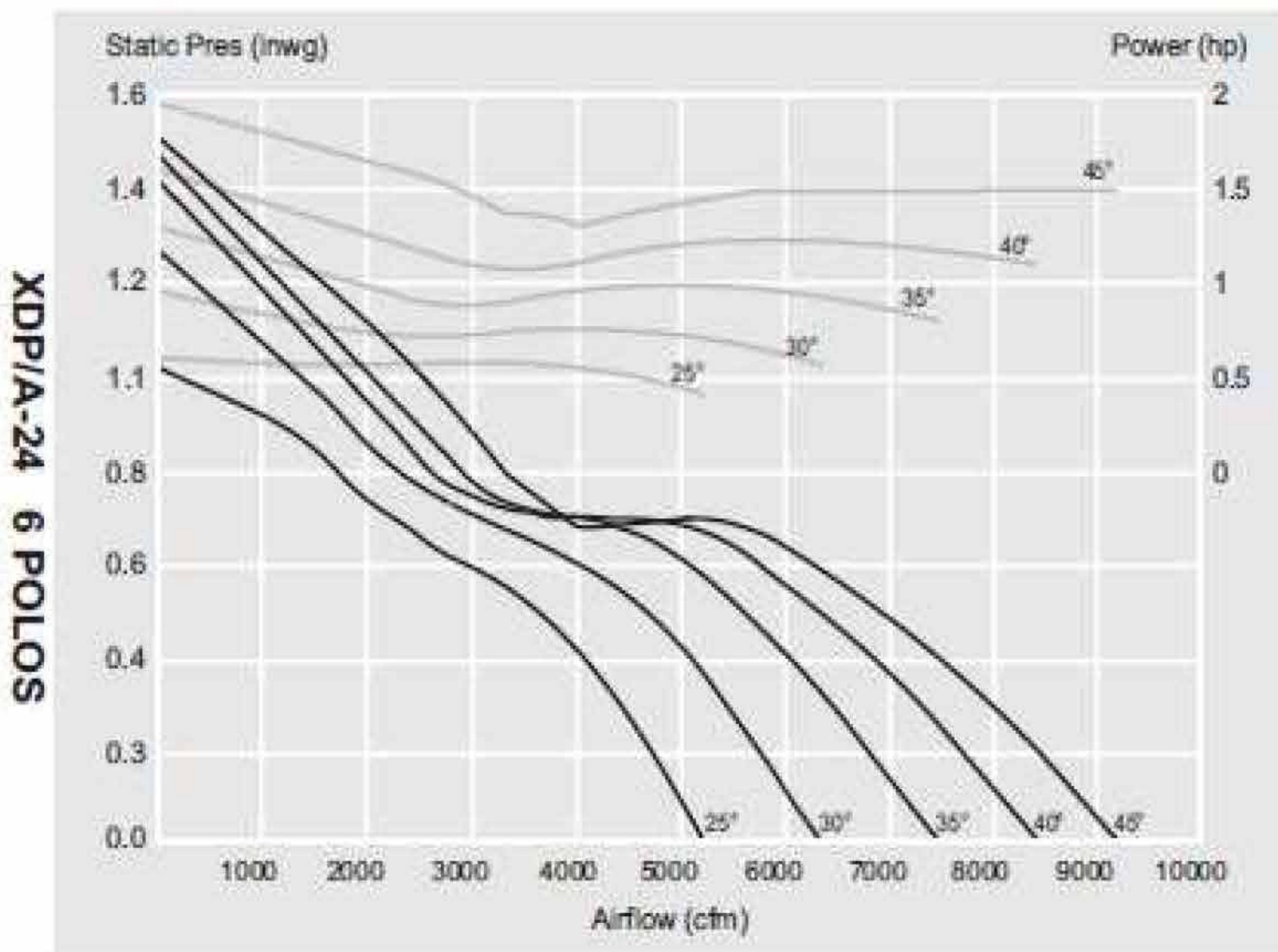
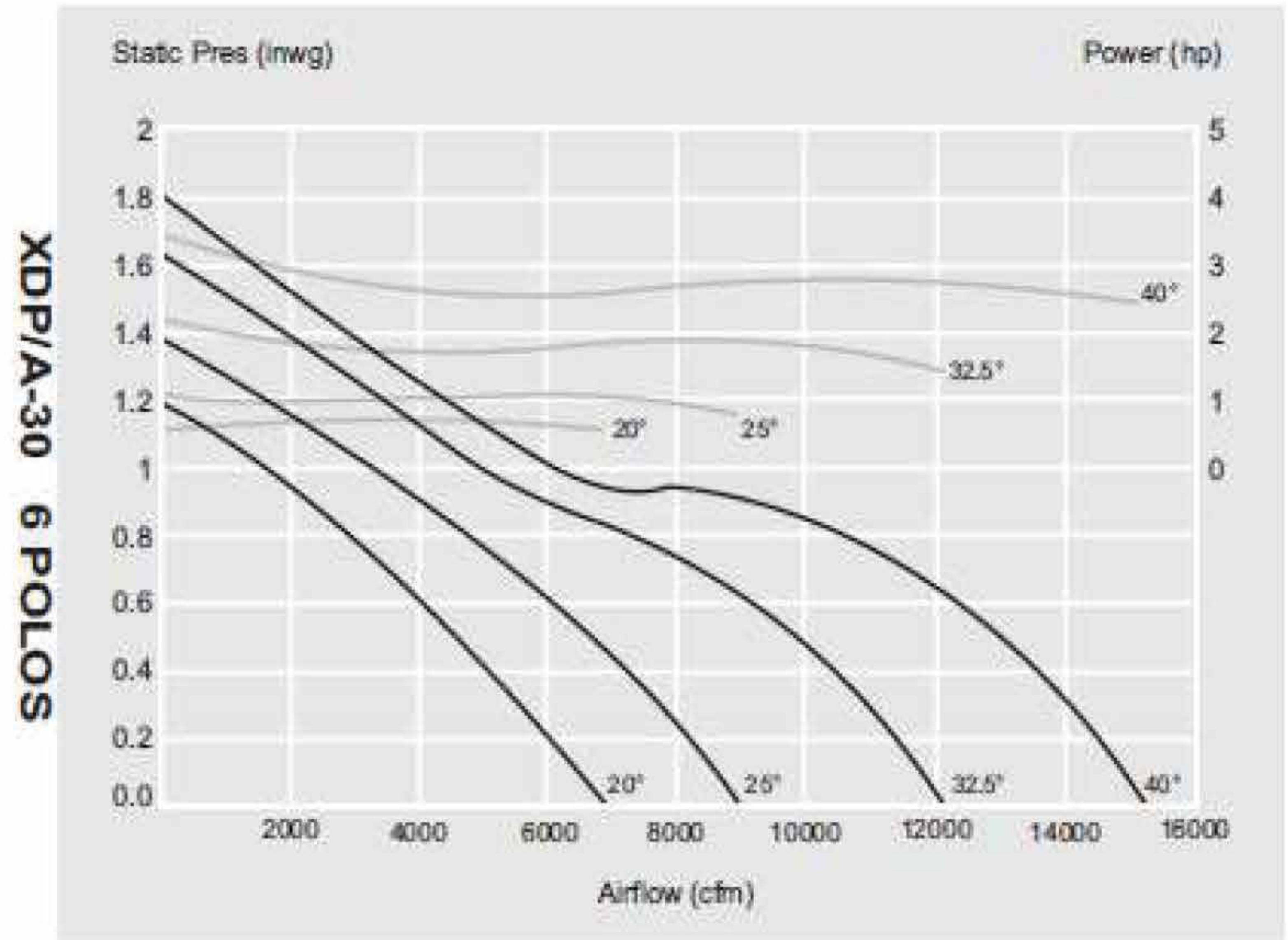
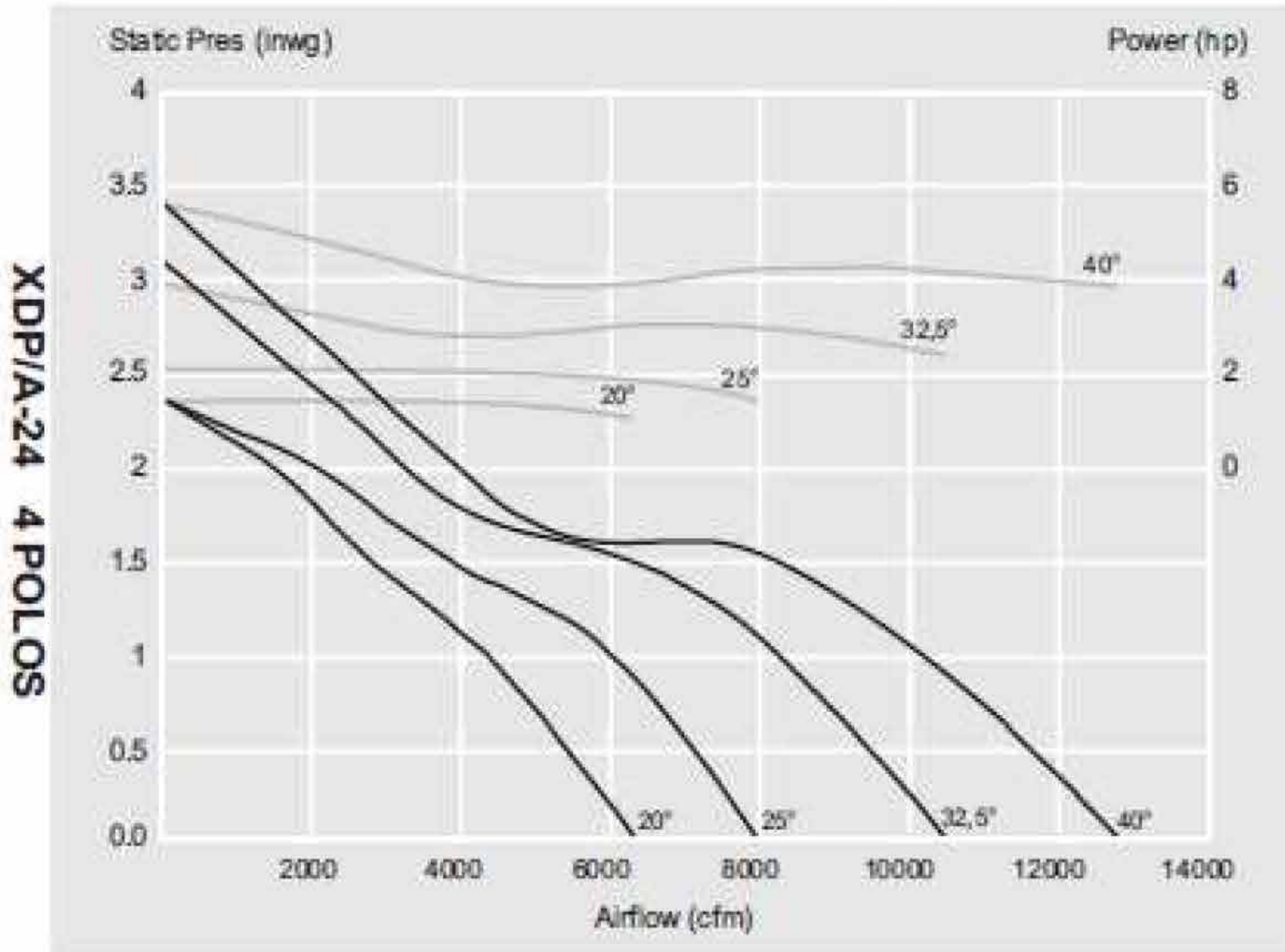

XDP/A

AERO EXTRACTOR – INYECTOR TUBO AXIAL ATC
 ALTA EFICIENCIA EN ACOPLAMIENTO DIRECTO
 ALABES AJUSTABLES DE 24", 30", 36", 42" DE DIÁMETRO

CURVAS DE OPERACIÓN (PERFORMANCE CURVES)

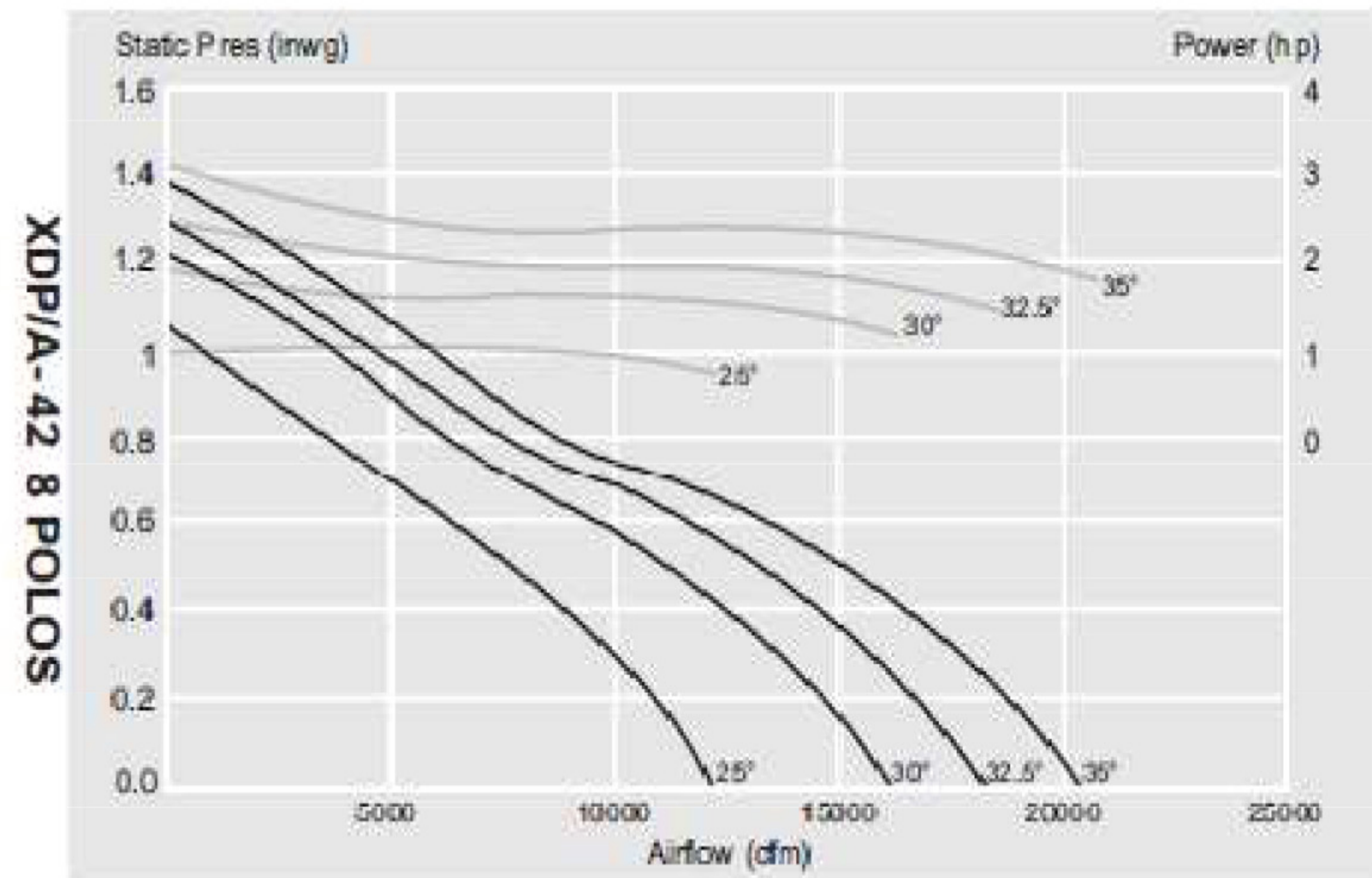
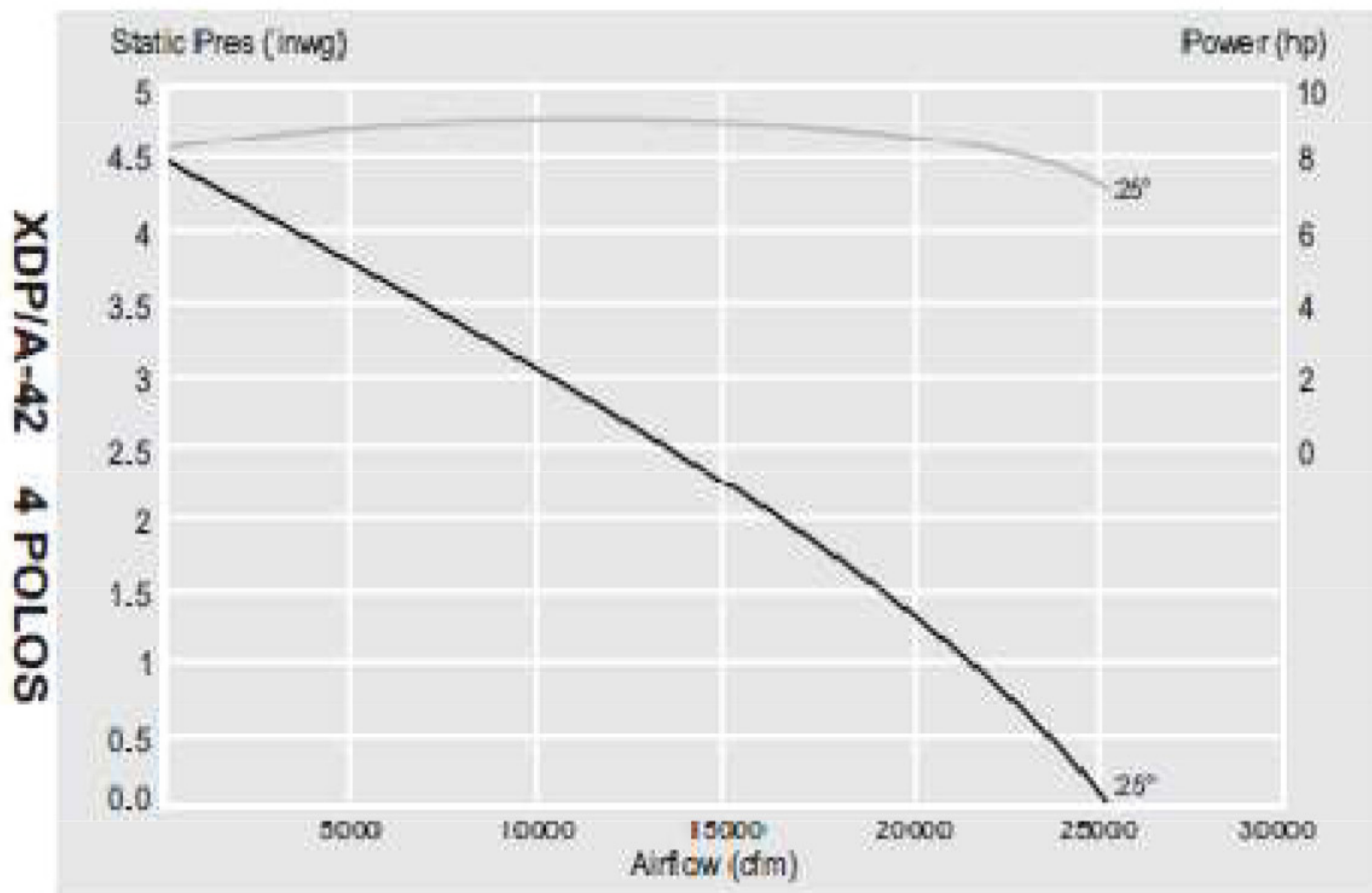
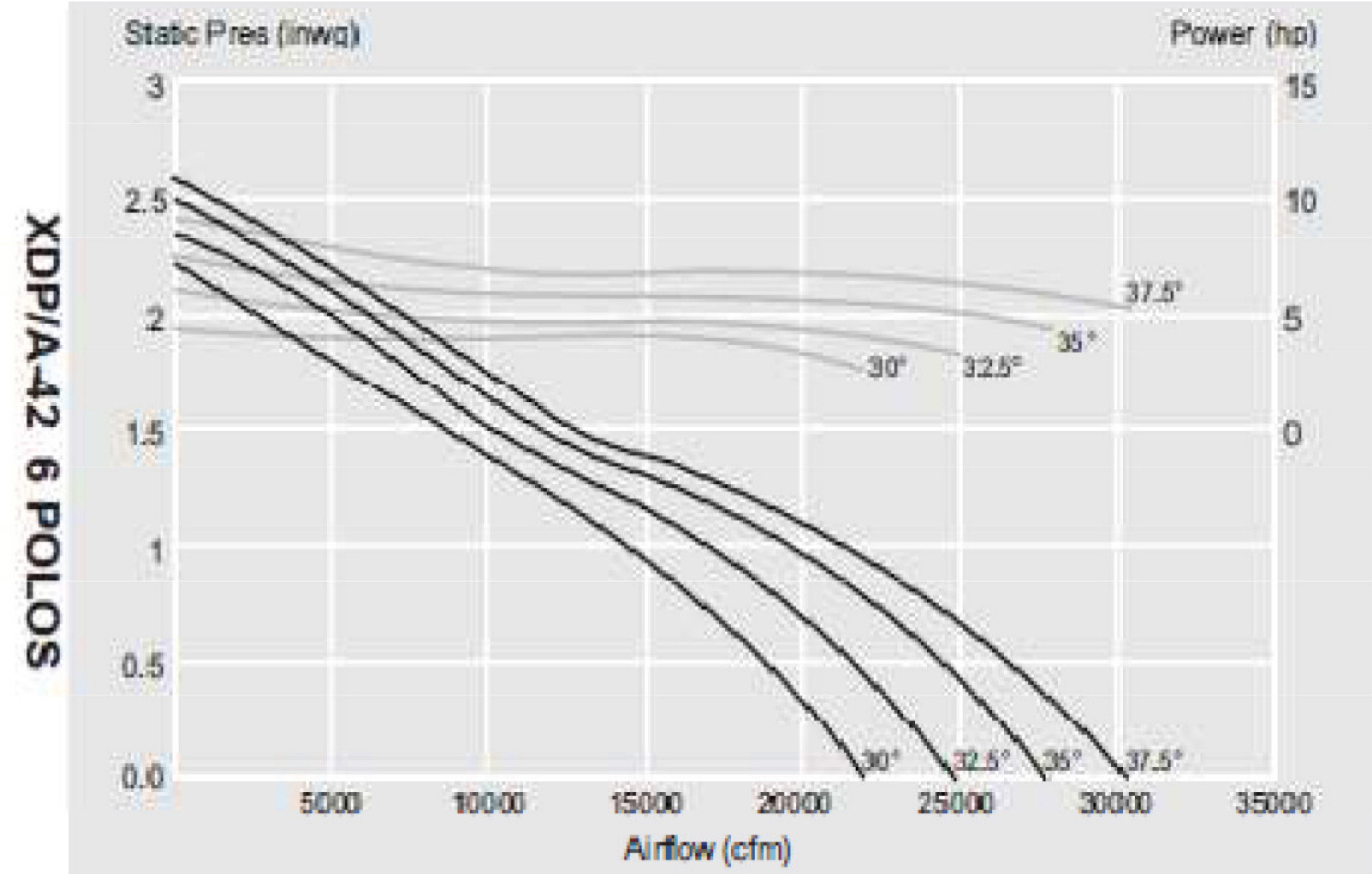
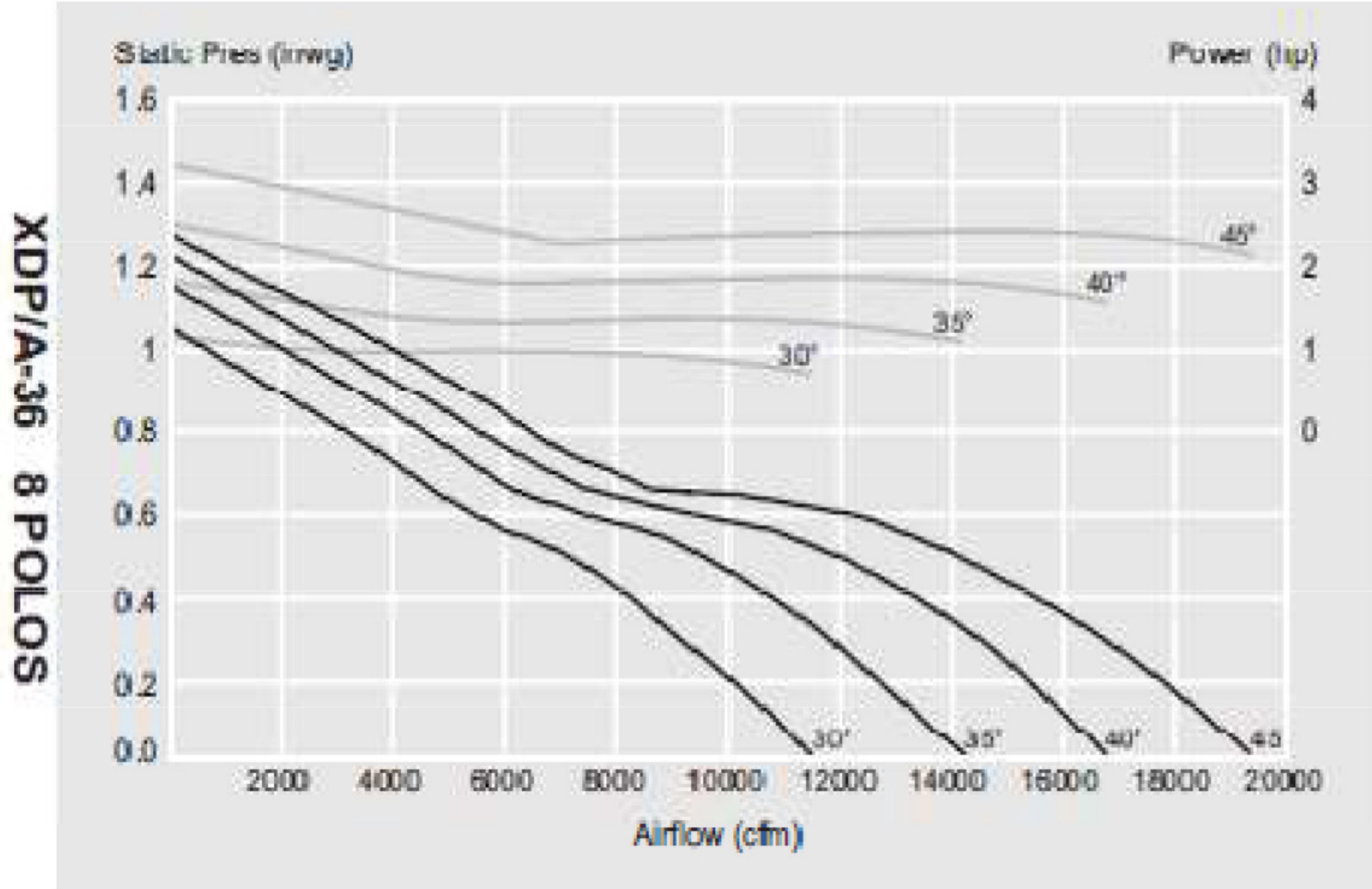

Hélice en Aluminio Inyectado



Cubo en Aluminio Inyectado (Hub Set)

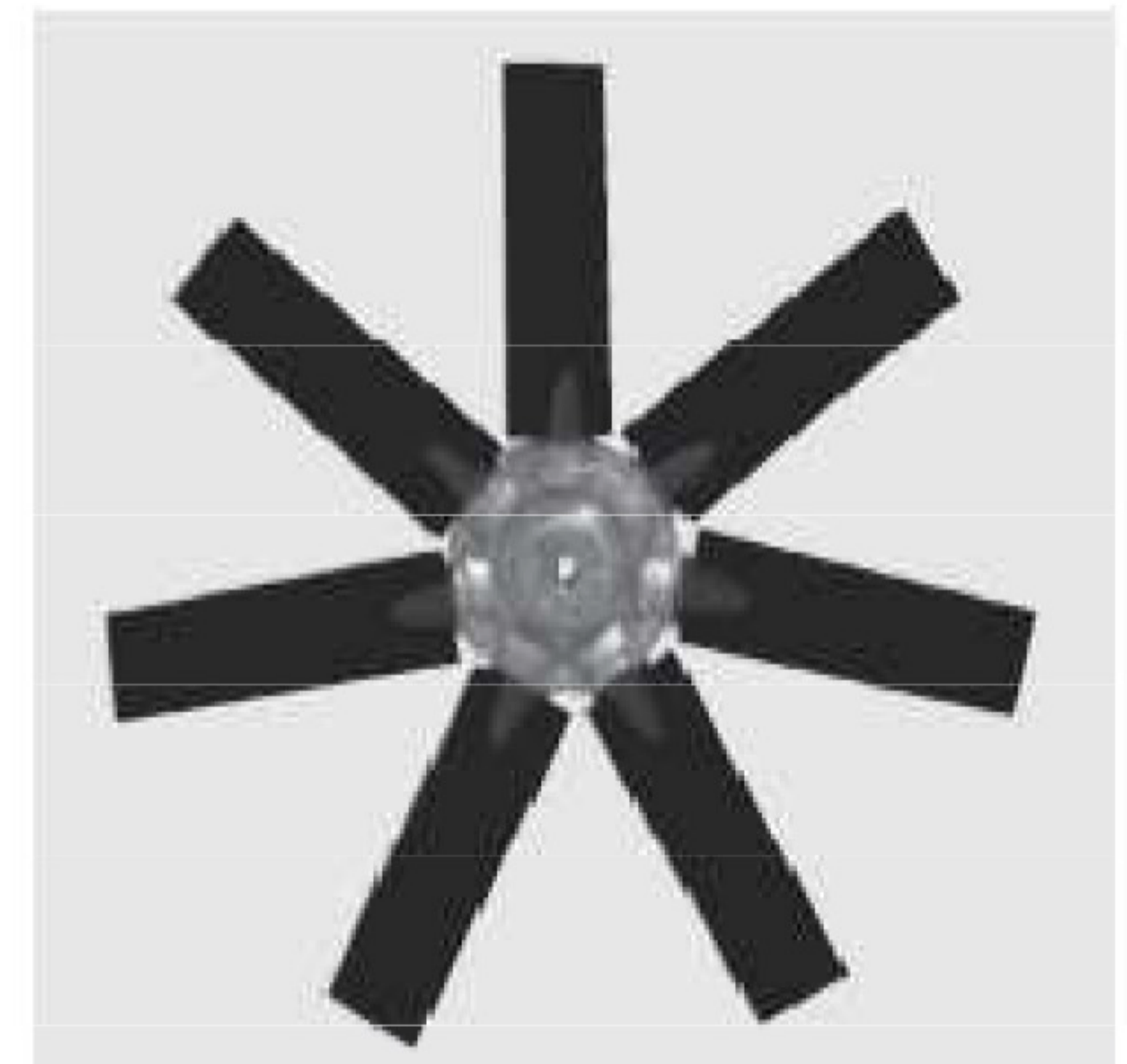

Hélice en Polipropileno reforzado con fibra de vidrio

MOMC
 ELECTRIC

CONTACTO

OFICINAS
 Santiago de Querétaro,
 Querétaro, México.

442 219 7860
 442 721 34 12
 442 106 35 73

info@extractoresindustrialesdeaire.com

Distribuidor Autorizado: