

**RUB
RUD
TUB**



**Aero extractores axiales de techo ATC
con compuerta tipo mariposa, línea Butterfly**
ATC Axial upblast roof exhaust fans with dampers, Butterfly Series

The Right Choice



The
Right
Choice

MOMC
E L E C T R I C





RUB/RUD/TUB

Indice

Características principales	2
Especificaciones técnicas RUB	4
Curvas de operación RUB	5
Especificaciones técnicas RUD	6
Curvas de operación RUD	7
Especificaciones técnicas TUB	8
Curvas de operación TUB	9
Dimensiones generales	10

Table of Contents

Construction features	3
Performance data RUB	4
Operation curves RUB	5
Performance data RUD	6
Operation curves RUD	7
Performance data TUB	8
Operation curves TUB	9
Dimensions	10



RUB/RUD/TUB

Aero extractores axiales de techo ATC con compuerta tipo mariposa, línea Butterfly. 24", 30", 36", 42", 48", 54", 60" de diámetro.

La línea de los Aero Extractores Axiales de Techo con compuerta tipo Mariposa marca ATC ha sido especialmente diseñada para descarga vertical de contaminantes muy lejos de edificios, almacenes y bodegas, evitando daño a los techos y la recirculación - regreso de aire contaminante en aplicaciones comerciales e industriales. La combinación de 7 diferentes diámetros de Hélice en ángulo fijo y de alabes en ángulo variable y distintos números de Polos de motores y las transmisiones en poleas y bandas genera gran variedad de Ventiladores que manejan un amplio rango de Caudales-Presiones en el Mercado.

Características principales

- Cuerpo, Marco Venturi y Soporte del motor fabricados en Acero al carbón con acabado en pintura poliéster en polvo horneada.
- Hélice de Lamina galvanizada aerodinámicamente balanceada en 5 y 6 alabes con acabado en pintura poliéster en polvo horneada altamente resistente a la corrosión (Modelos RUB-24, 30, 36, 42 y 48).
- Hélice de Polipropileno reforzado con fibra de vidrio de 6 alabes en ángulo variable anti-chispa y balanceada dinámicamente (Modelos RUB- 54 y RUB-60).
- Hélice de Aluminio inyectado o Polipropileno reforzado con fibra de vidrio de 6 y 7 alabes en ángulo variable, balanceada dinámicamente, anti-chispa, altamente resistente a la corrosión (Modelos RUD y TUB).
- Compuerta anti-retorno tipo Mariposa fabricada en Aluminio calibres 16 y 14 según modelos con canal de desagüe, pernos y tornillería en Acero Inoxidable.
- Malla de protección en la succión es Estándar en todos los Modelos y malla de protección a la descarga es un accesorio opcional.
- Accionado por Transmisión de Poleas-Bandas y chumaceras con rodamientos de uso continuo a los Motores Eléctricos de Eficiencia Premium en 4 polos, diseñados bajo las especificaciones NEMA (Modelos RUB y TUB).
- Accionado por acoplamiento directo a los Motores Eléctricos Trifásicos de Eficiencia Premium de 4,6 y 8 polos diseñados bajo las especificaciones NEMA (Modelo RUD).

Nomenclatura:

RU B - 24 / L

1 2 3 4

1. Modelo
2. Transmisión de poleas y banda.
3. Diámetro de hélice en pulgadas.
4. Revoluciones por minuto en modelos RUB-24, 30, 36, 42 y 48.
L: RPM baja.
M: RPM media.
H: RPM alta.
o grado de inclinación de los álabes en modelos RUB-54 y 60.

RU D -P/A- 4 - 24 /30

1 2 3 4 5 6

1. Modelo
2. Acoplamiento Directo
3. Tipo de hélice
P-Plástico
A-Aluminio
4. No. de polos del motor
5. Diámetro de hélice en pulgadas
6. Grado de inclinación de los álabes.

TU B -P/A- 42 /30

1 2 3 4 5

1. Modelo
2. Transmisión de poleas y banda.
3. Tipo de hélice
P-Plástico
A-Aluminio
4. Diámetro de hélice en pulgadas
5. Grado de inclinación de los álabes.



RUB/RUD/TUB

ATC Axial upblast roof exhaust fans with dampers, butterfly series.
24", 30", 36", 42", 48", 54" and 60" diameters.

The RUB/RUD/TUB Series are belt drive, direct drive axial and tube axial roof exhaust fans with butterfly dampers designed to discharge the contaminated air up and away from the buildings, warehouses, industrial plants to prevent roof damage and recirculation of exhaust air. The combination of 7 different diameters of fan blades in fixed and variable pitch angles, distinct number of motor poles (RPM) and pulleys and belts generate a wide range of top performance fans with high airflow and pressure in today's market

Construction features

- The fan frame, inlet cone, tubular housing, windbands, drive stands are made of heavy gauge all welded steel construction with a corrosion resistant electrostatically applied polyester powder coating finish.
- The high performance galvanized fan blades in fixed angles, statically and dynamically balanced in 5 and 6 blade presentation are used for models RUB-24, 30, 36, 42 & 48.
- The corrosion resistance polypropylene reinforced fiberglass fan blades in variable pitch angles and 6 blade presentation are used for Models RUB- 54 and RUB-60.
- The non-spark die cast aluminum or polypropylene reinforced fiberglass fan blades in variable pitch angles and 6 & 7 blade presentation are used for Models RUD and TUB.
- The butterfly dampers are made of light weight aluminum gauges 18 & 16 for corrosion resistance. Dampers are designed with rolled edges for strength and are assembled with stainless steel rod mechanism and rubber bumpers for quiet operation.
- Galvanized welded wire guard on intake is standard on all models and the outlet screen is an optional accessory.
- ATC Axial and tubo axial upblast roof exhaust fans are the ideal choice for the industrial applications by using the direct drive (RUD) and the combination of high quality sheaves, v-belts (RUB, TUB), high efficiency motors in order to handle a wide range of airflow and pressures.

Nomenclature:

RU B - 24 / L

1 2 3 4

1. Fan model.
2. Belt drive.
3. Fan blade diameter in inches .
4. Fan RPM for models RUB- 24 through RUB-48
L: Low RPM.
M: Medium RPM.
H: High RPM.
Or pitch degree angle for models RUB- 54 and RUB- 60

RU D - P/A - 4 - 24 /30

1 2 3 4 5 6

1. Fan model.
2. Direct drive.
3. Type of fan blade
P: Plastic
A: Aluminium.
4. No. of motor poles.
5. Fan blade diameter in inches.
6. Pitch degree angle.

TU B - P/A - 42 /30

1 2 3 4 5

1. Fan model.
2. Belt drive.
3. Type of fan blade
P: Plastic.
A: Aluminium.
4. Fan blade diameter in inches.
5. Pitch degree angle.

Aero extractores axiales de techo ATC con transmisión de poleas y bandas, línea Butterfly.
ATC Belt Drive Axial upblast roof exhaust fans, Butterfly series.

Especificaciones técnicas / Performance data

MODELO MODEL	CAUDAL @ DESCARGA LIBRE AIR FLOW		AMPERAJE (A) @ 60 HZ CURRENT (A) @ 60 HZ				POTENCIA POWER (HP)	RPM VENTILADOR FAN RPM	NIVEL SONORO SOUND LEVEL dB (A)*	PESO APROXIMADO APPROXIMATE WEIGHT	
	CFM	M3/HR	3 FASES 3 PHASE		1 FASE 1 PHASE					Lb.	Kg.
			220V	440V	220V	127V					
RUB-24/L**	4,592	7,802	2.1	1.1	4.0	8.5	1/2	725	65	97	44
RUB-24/M	5,510	9,362	2.1	1.1	4.0	8.5	1/2	870	66	97	44
RUB-24/H	6,428	10,921	3.0	1.5	5.5	12.5	3/4	1015	67	103	47
RUB-30/L	7,547	12,823	2.1	1.1	4.0	8.5	1/2	609	66	110	50
RUB-30/M	8,675	14,739	3.0	1.5	5.5	12.5	3/4	700	67	116	53
RUB-30/H	9,765	16,591	3.0	1.5	5.5	12.5	3/4	788	68	116	53
RUB-36/L	10,971	18,640	3.0	1.5	5.5	12.5	3/4	525	67	126	57
RUB-36/M	12,726	21,621	3.0	1.5	5.5	12.5	3/4	609	68	126	57
RUB-36/H	14,628	24,853	4.2	2.1	6.8	15.0	1	700	69	132	60
RUB-42/L	14,555	24,729	3.0	1.5	5.5	12.5	3/4	438	68	148	67
RUB-42/M	17,446	29,641	4.2	2.1	6.8	15.0	1	525	70	156	71
RUB-42/H	20,237	34,383	5.2	2.6	10.6	21.3	1 1/2	609	71	178	81
RUB-48/L	21,735	36,928	4.2	2.1	6.9	15.0	1	438	73	180	82
RUB-48/M	23,968	40,722	5.2	2.6	10.6	21.3	1 1/2	525	74	191	87
RUB-48/H	27,802	47,236	8.0	4.0	15.5	33.3	2	609	75	194	88

MODELO MODEL	CAUDAL @ DESCARGA LIBRE AIR FLOW		AMPERAJE (A) CURRENT (A) 3 FASES 3 PHASE @60 Hz		POTENCIA POWER (HP)	RPM VENTILADOR FAN RPM	NIVEL SONORO SOUND LEVEL dB (A)*	PESO APROXIMADO APPROXIMATE WEIGHT	
	CFM	M3/HR	220 V	440V				Lb.	Kg.
RUB-54/30°	31,400	53,349	9.8	4.9	3.0	550	70	422	192
RUB-54/36°	38,300	65,072	15.0	7.5	5.0	550	75	447	203
RUB-54/43°	45,000	76,455	23.0	11.5	7.5	550	78	508	231
RUB-54/48°	48,900	83,081	26.0	13.0	10.0	550	80	532	242
RUB-60/30°	38,600	65,581	9.8	4.9	3.0	550	77	436	198
RUB-60/36°	47,500	80,702	15.0	7.5	5.0	550	82	458	208
RUB-60/43°	57,500	97,692	23.0	11.5	7.5	550	86	521	237
RUB-60/48°	63,000	107,037	26.0	13.0	10.0	550	88	543	247

* Nivel sonoro medido a 1.50 metros (5 pies) de la fuente en un campo hemisférico libre según AMCA Standar 301.

Sound pressure measured in a free field with 1/2 spherical propagation at a distance of 1.5 meters (5 feet) from the source according to AMCA Standard 301.

** L: RPM Baja-Low RPM / M: RPM Media-Medium RPM / H: RPM Alta-High RPM

Curvas de operación / Performance curves

RUB-24

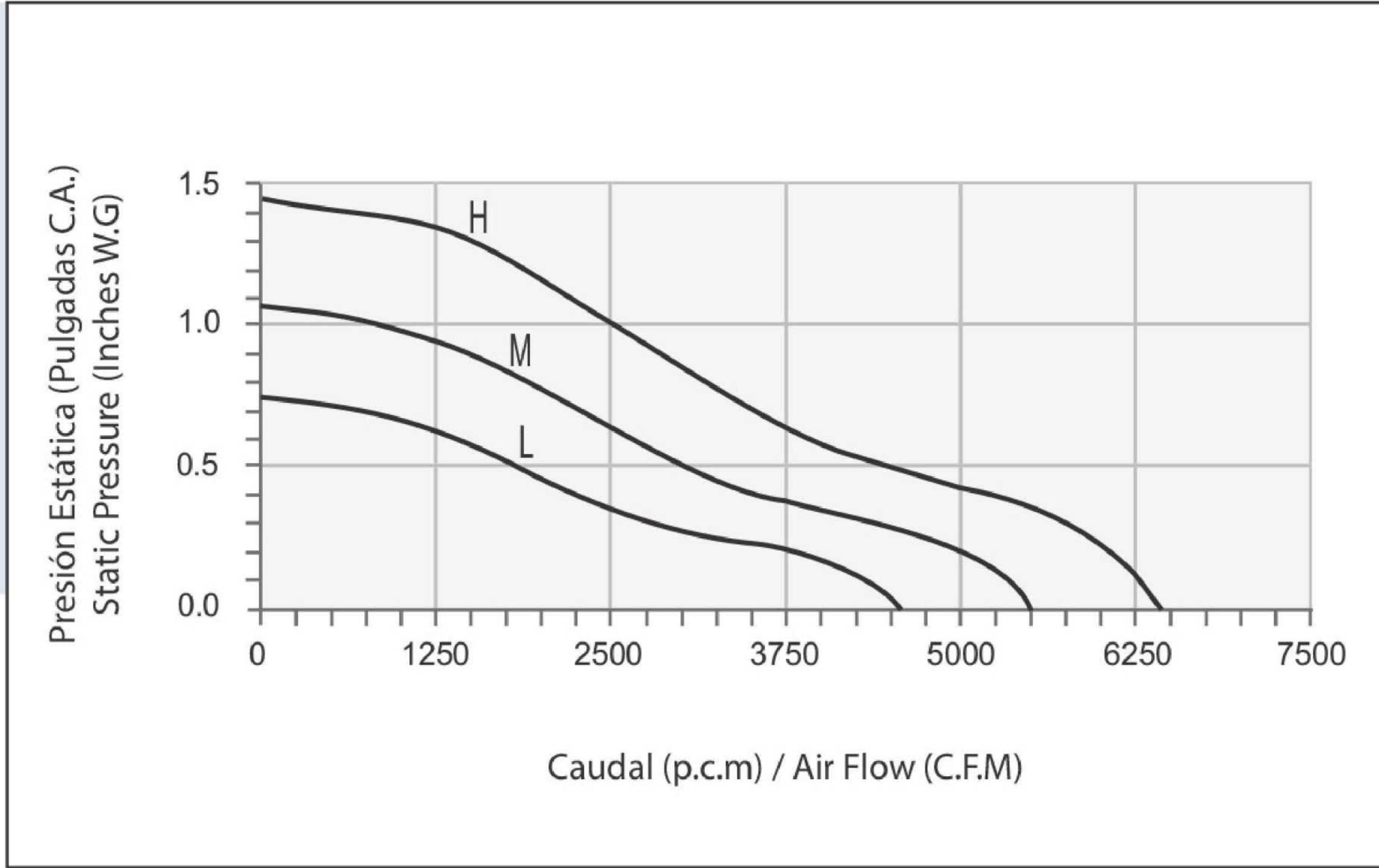

RUB-48

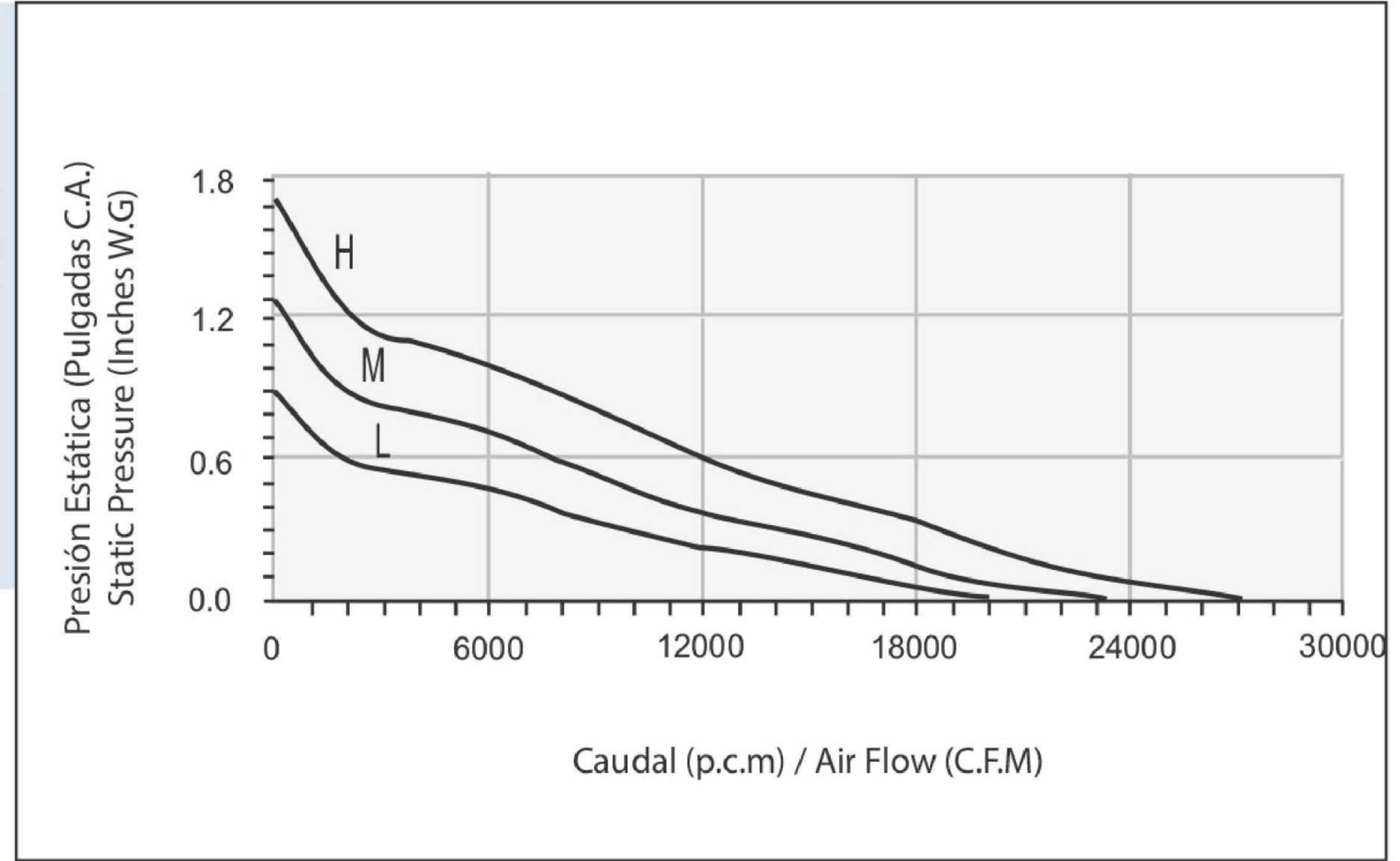

RUB-30

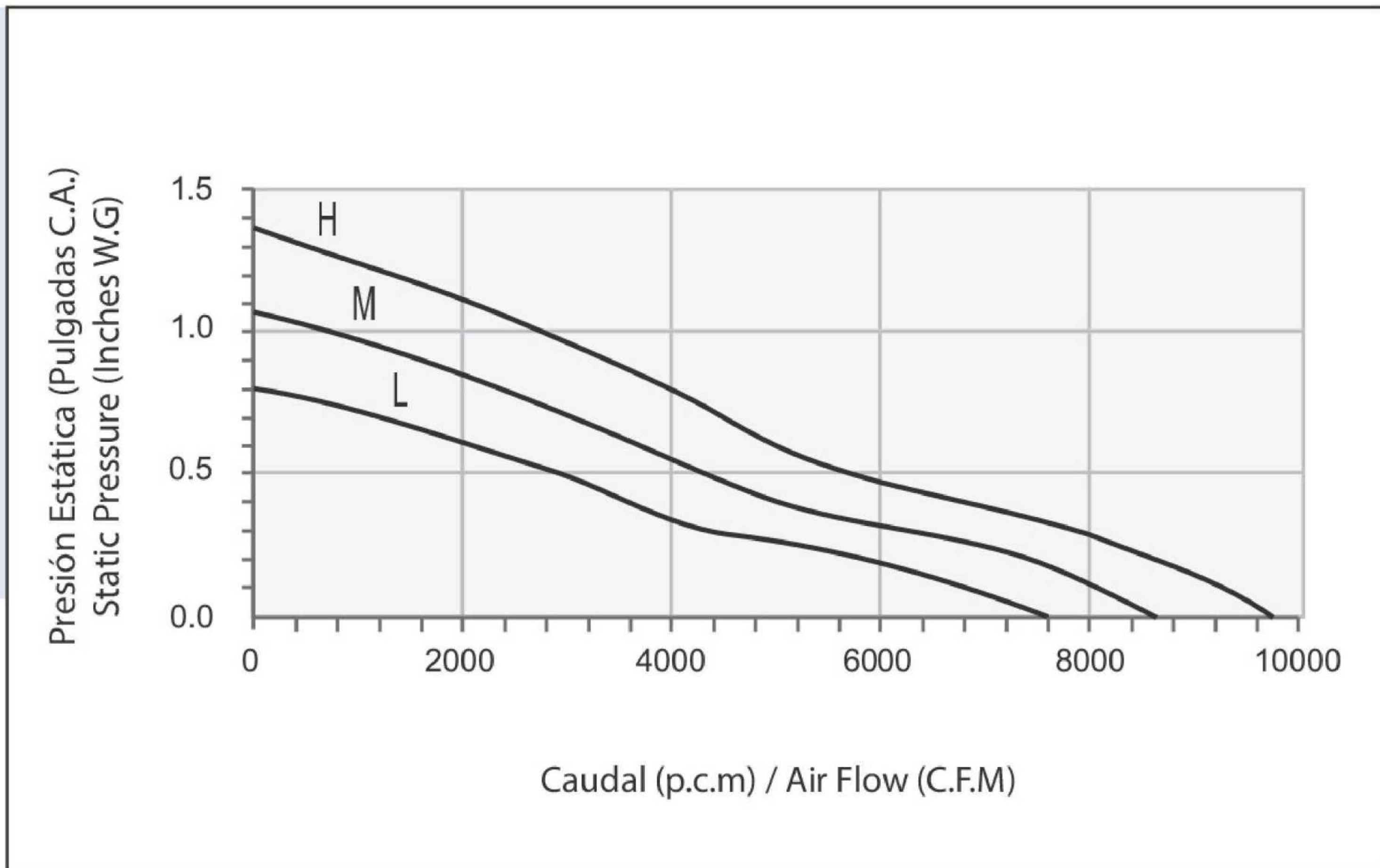

RUB-54

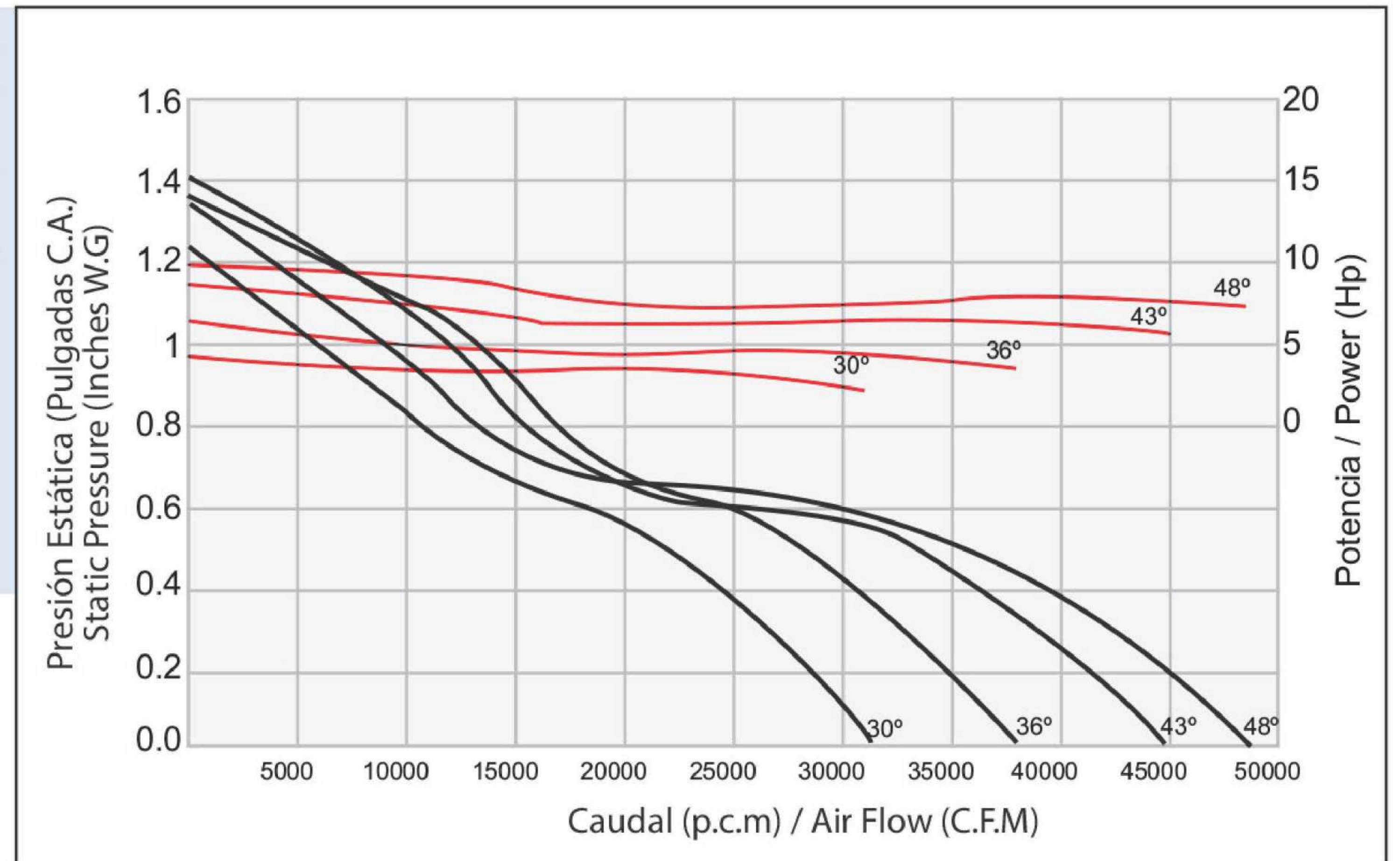

RUB-36

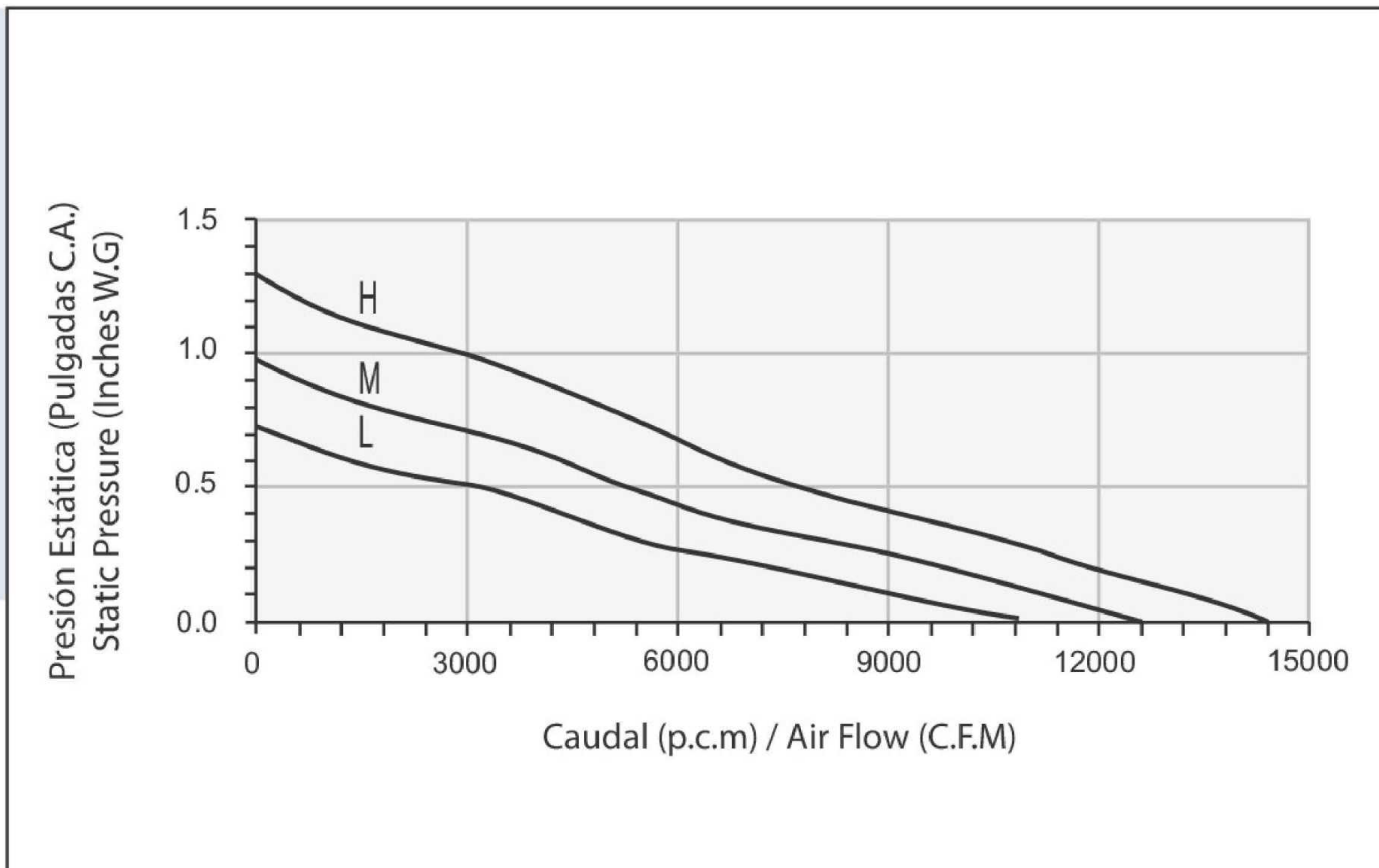

RUB-60

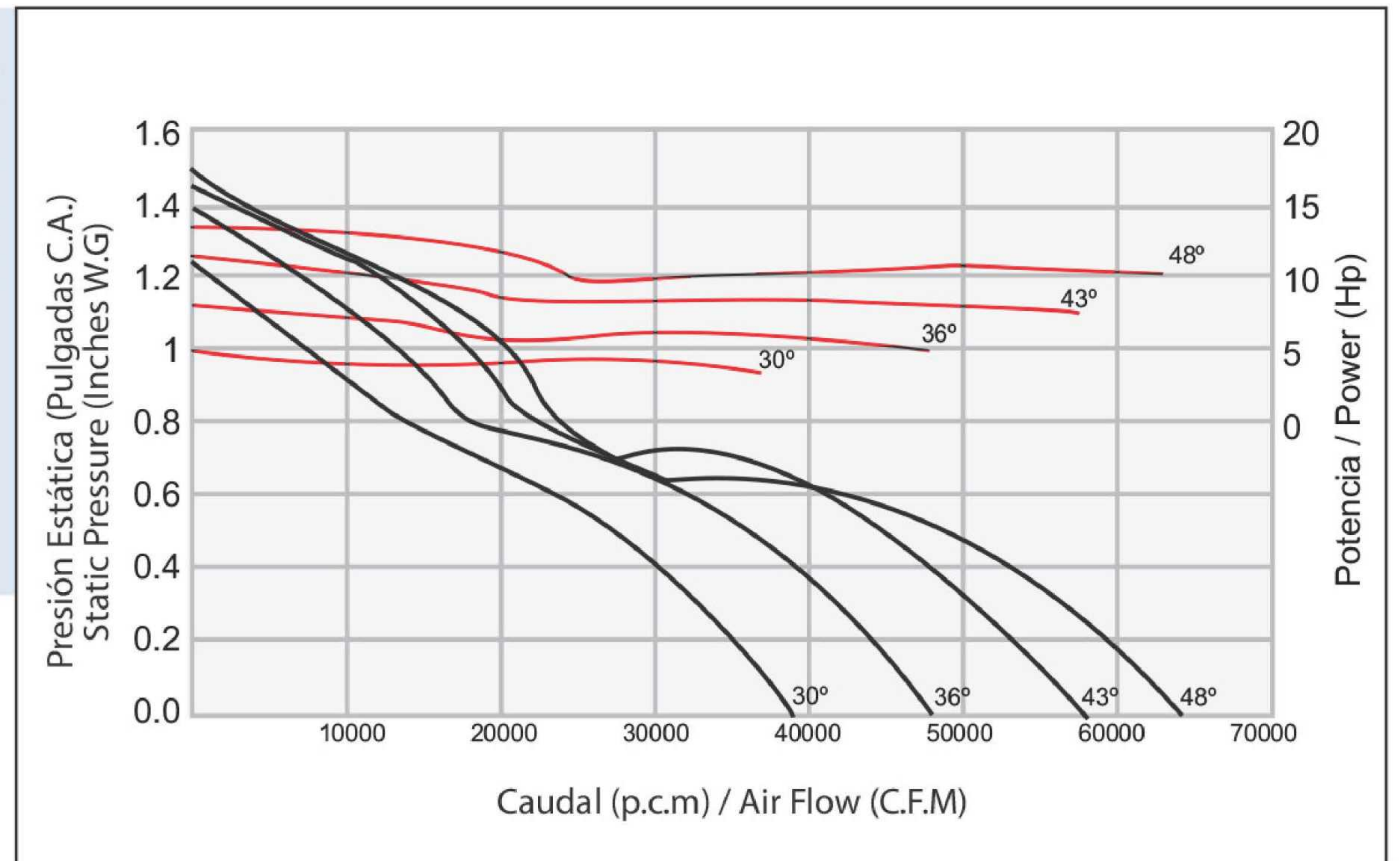

RUB-42

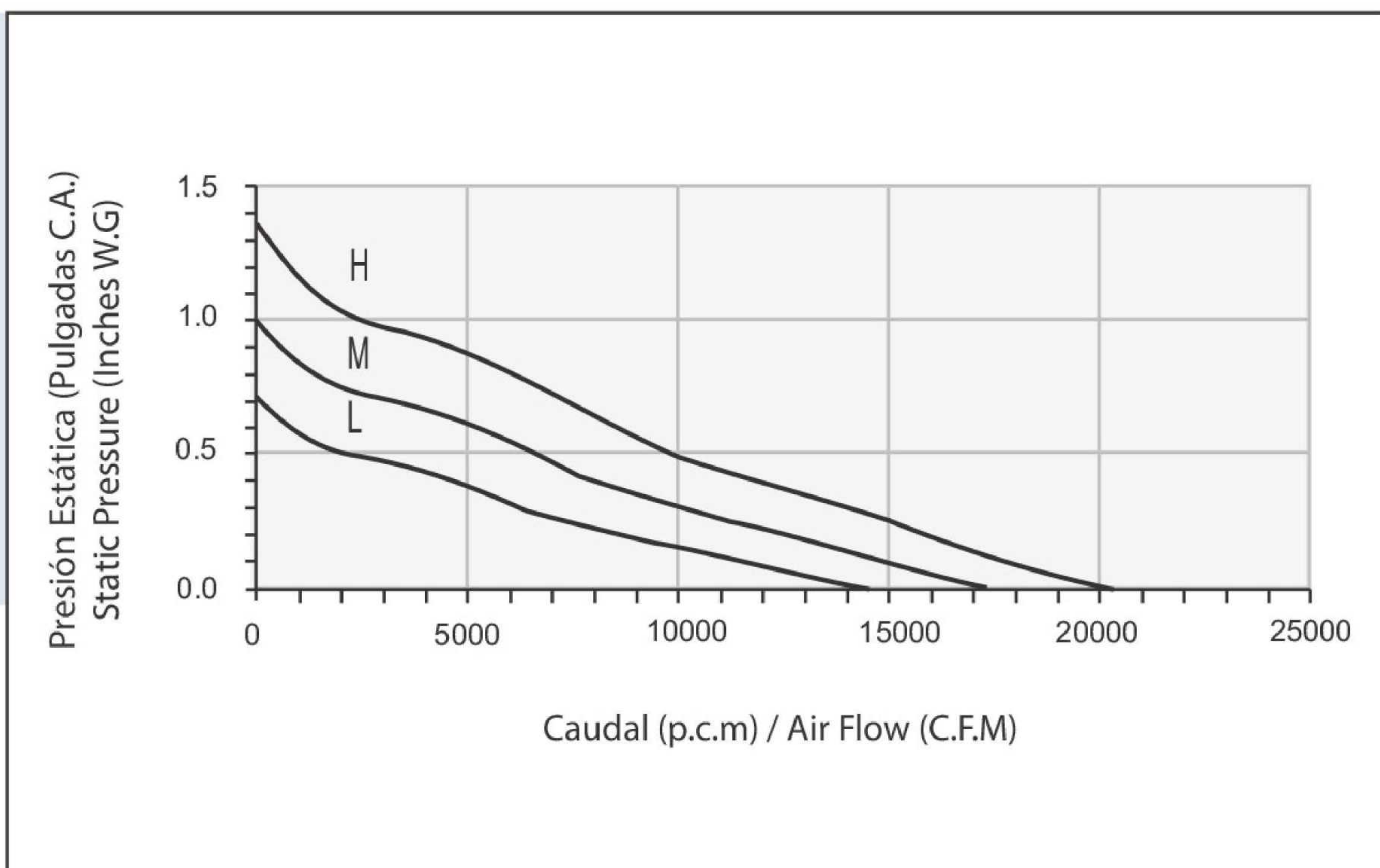

Aero extractores axiales de techo ATC en acoplamiento directo, línea Butterfly.
 ATC Direct Drive Axial upblast roof exhaust fans, Butterfly series.

Especificaciones técnicas / Performance data

MODELO MODEL	CAUDAL @ DESCARGA LIBRE AIR FLOW		AMPERAJE (A) CURRENT (A)		POTENCIA POWER (HP)	VENTILADOR RPM FAN RPM	NIVEL SONORO SOUND LEVEL dB (A)*	PESO APROX. APPROXIMATE WEIGHT	
			3 FASES @ 60 HZ 3 PHASE @ 60 HZ					Lb.	Kg.
	CFM	M3/HR	220 V	440V					
RUD-4-24/20°	6,350	10,789	5.2	2.6	1.5	1760	64	75	34
RUD-4-24/25°	7,970	13,541	6.6	3.3	2.0	1760	69	77	35
RUD-4-24/32.5°	10,500	17,840	9.8	4.9	3.0	1760	75	110	50
RUD-4-24/40°	12,800	21,747	15.0	7.5	5.0	1760	79	114	52
RUD-6-24/25°	5,250	8,920	2.4	1.2	1/2	1160	60	59	27
RUD-6-24/30°	6,360	10,806	2.8	1.4	3/4	1160	64	64	29
RUD-6-24/35°	7,500	12,743	3.8	1.9	1.0	1160	67	68	31
RUD-6-24/40°	8,440	14,340	4.8	2.4	1.5	1160	70	101	46
RUD-6-24/40°	9,200	15,631	6.2	3.1	2.0	1160	72	103	47
RUD-4-30/20°	10,500	17,840	6.6	3.3	2.0	1760	73	86	39
RUD-4-30/25°	13,600	23,106	9.8	4.9	3.0	1760	78	119	54
RUD-4-30/30°	16,700	28,373	15.0	7.5	5.0	1760	83	123	56
RUD-4-30/32.5°	18,400	31,262	15.0	7.5	5.0	1760	85	123	56
RUD-6-30/20°	6,900	11,723	2.8	1.4	3/4	1160	64	73	33
RUD-6-30/25°	8,950	15,206	3.8	1.9	1.0	1160	69	77	35
RUD-6-30/32.5°	12,100	20,558	6.2	3.1	2.0	1160	76	110	50
RUD-6-30/40°	15,200	25,825	8.4	4.2	3.0	1160	81	141	64
RUD-4-36/25°	18,300	31,092	15.0	7.5	5.0	1760	73	167	76
RUD-4-36/30°	23,600	40,096	23.0	11.5	7.5	1760	78	180	82
RUD-6-36/25°	12,100	20,558	4.8	2.4	1.5	1160	64	119	54
RUD-6-36/30°	15,500	26,335	6.2	3.1	2.0	1160	69	139	63
RUD-6-30/35°	19,300	32,791	8.4	4.2	3.0	1160	74	154	70
RUD-6-30/40°	22,600	38,397	14.2	7.1	5.0	1160	77	205	93
RUD-8-36/30°	11,500	19,539	4.0	2.0	1.0	860	63	141	64
RUD-8-36/35°	14,300	24,296	5.4	2.7	1.5	860	67	154	70
RUD-8-36/40°	16,800	28,543	7.0	3.5	2.0	860	71	185	84
RUD-8-36/40°	19,500	33,131	9.8	4.9	3.0	860	74	194	88
RUD-4-42/25°	25,100	42,645	23.0	11.5	7.5	1760	80	196	89
RUD-6-42/30°	22,000	37,378	8.4	4.2	3.0	1160	77	172	78
RUD-6-42/32.5°	25,000	42,475	14.2	7.1	5.0	1160	80	222	101
RUD-6-42/35°	28,100	47,742	14.2	7.1	5.0	1160	82	222	101
RUD-6-42/37.5°	30,500	51,820	20.0	10.0	7.5	1160	84	315	143
RUD--8-42/25°	12,300	20,898	4.0	2.0	1.0	860	65	156	71
RUD-8-42/30°	16,300	27,694	5.4	2.7	1.5	860	71	172	78
RUD-8-42/32.5°	18,600	31,601	7.0	3.5	2.0	860	73	200	91
RUD-8-42/35°	20,800	35,339	9.8	4.9	3.0	860	76	211	96

* Nivel sonoro medido a 1.50 metros (5 pies) de la fuente en un campo hemisférico libre según AMCA Standar 301.

Sound pressure measured in a free field with 1/2 spherical propagation at a distance of 1.5 meters (5 feet) from the source according to AMCA Standard 301.

** L: RPM Baja-Low RPM / M: RPM Media-Medium RPM / H: RPM Alta-High RPM

Curvas de operación / Performance curves

RUD-24 4 POLOS

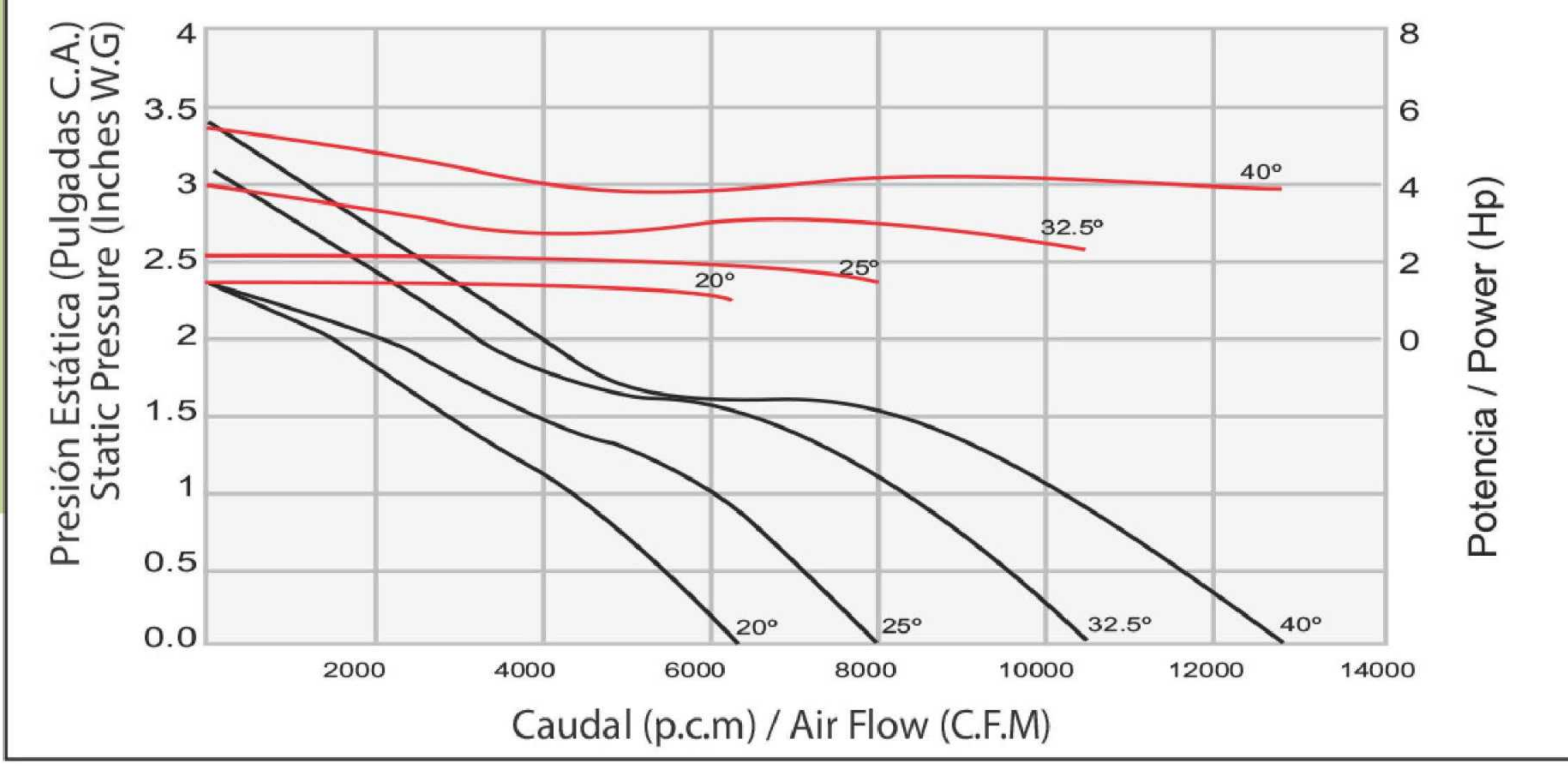

RUD-36 6 POLOS

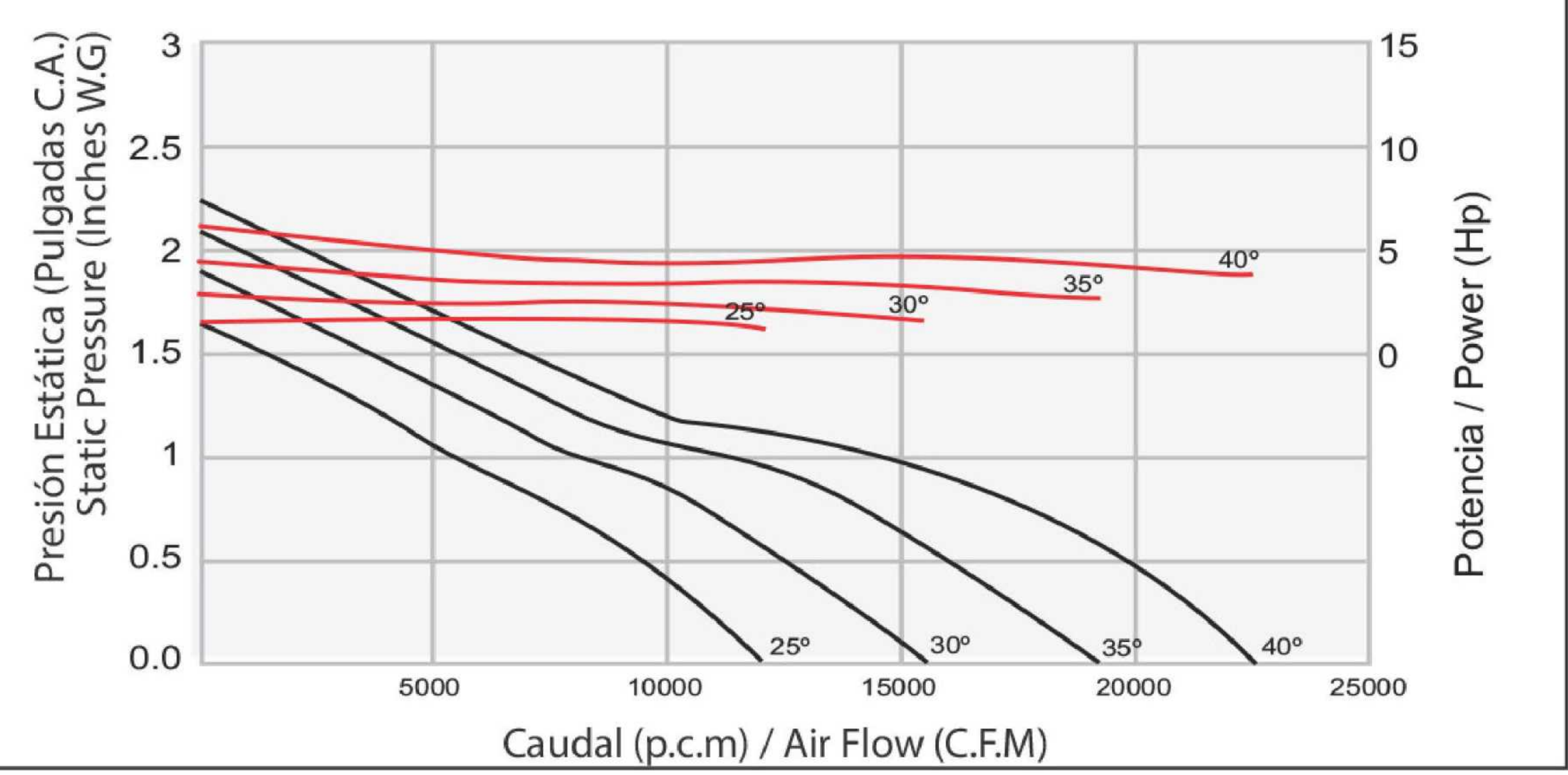

RUD-24 6 POLOS

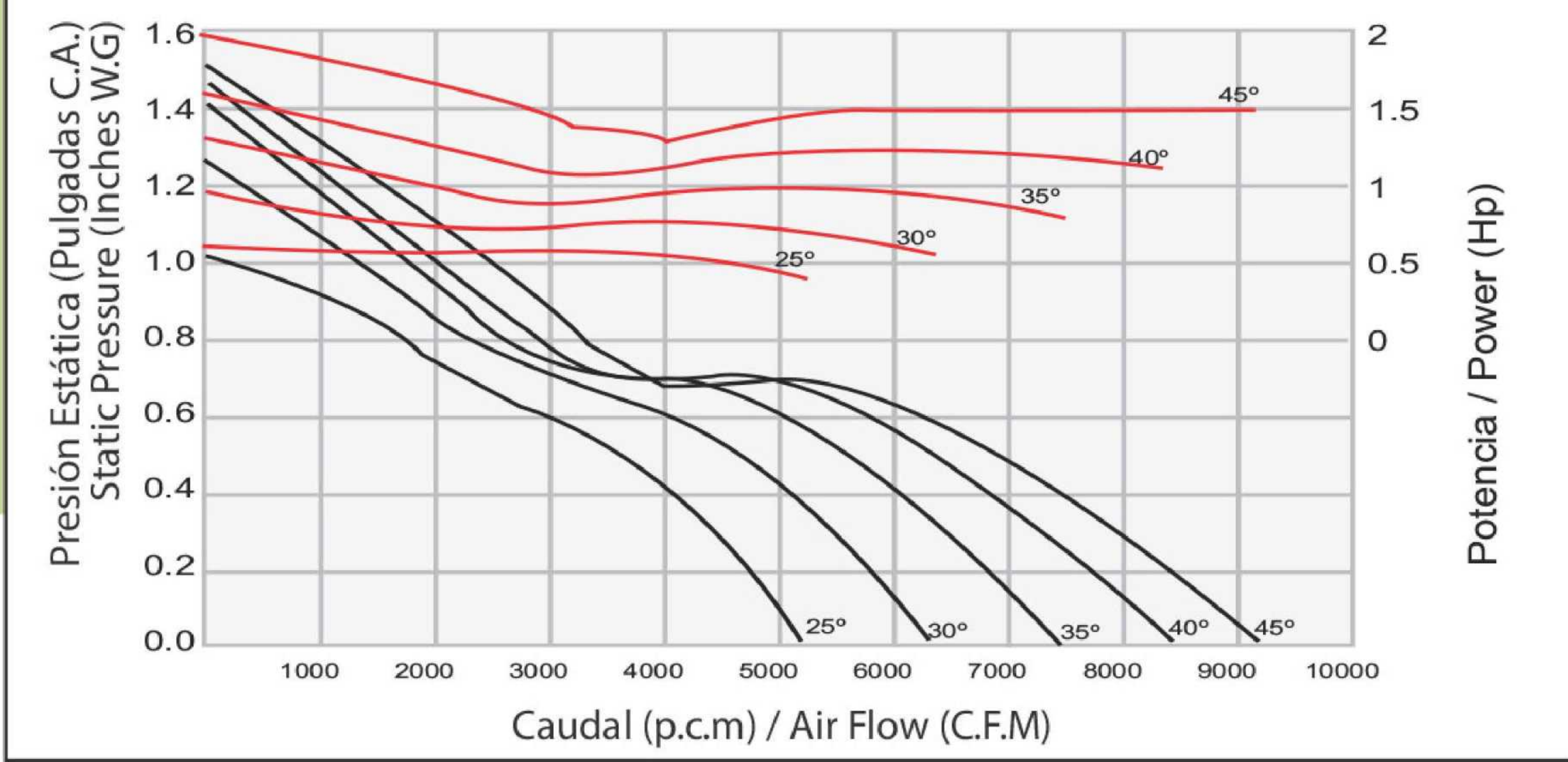

RUD-36 8 POLOS

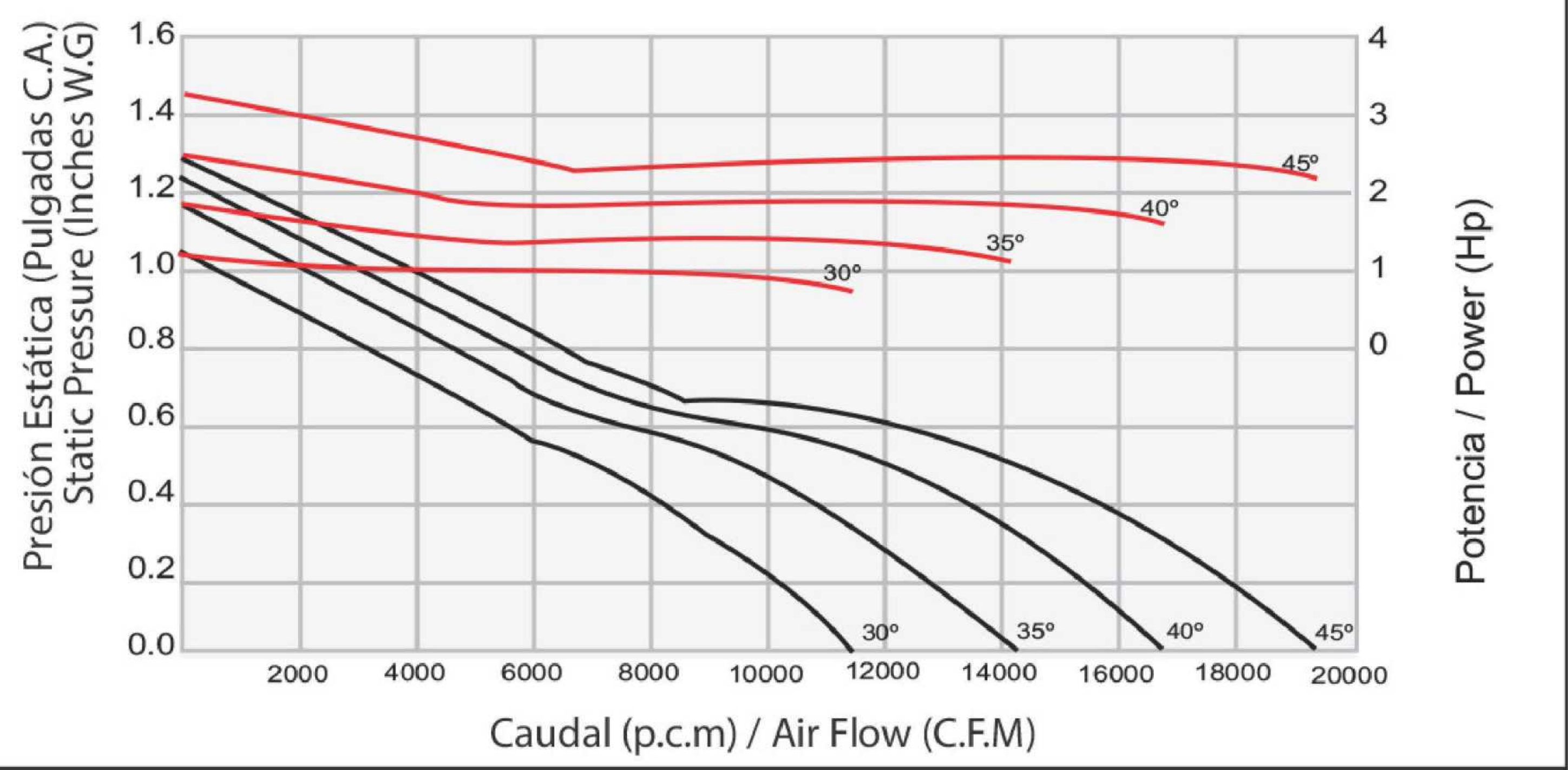

RUD-30 4 POLOS

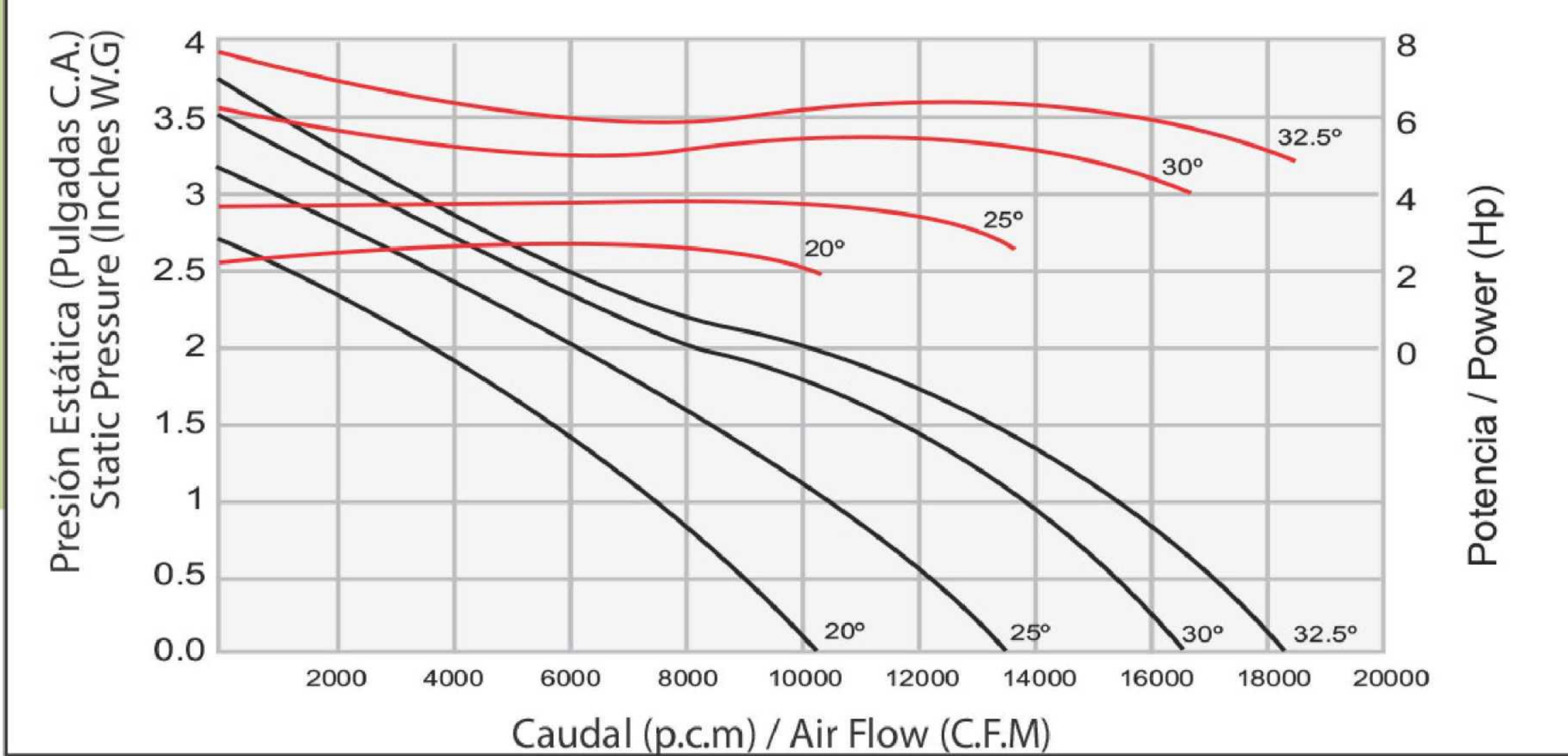

RUD-42 4 POLOS

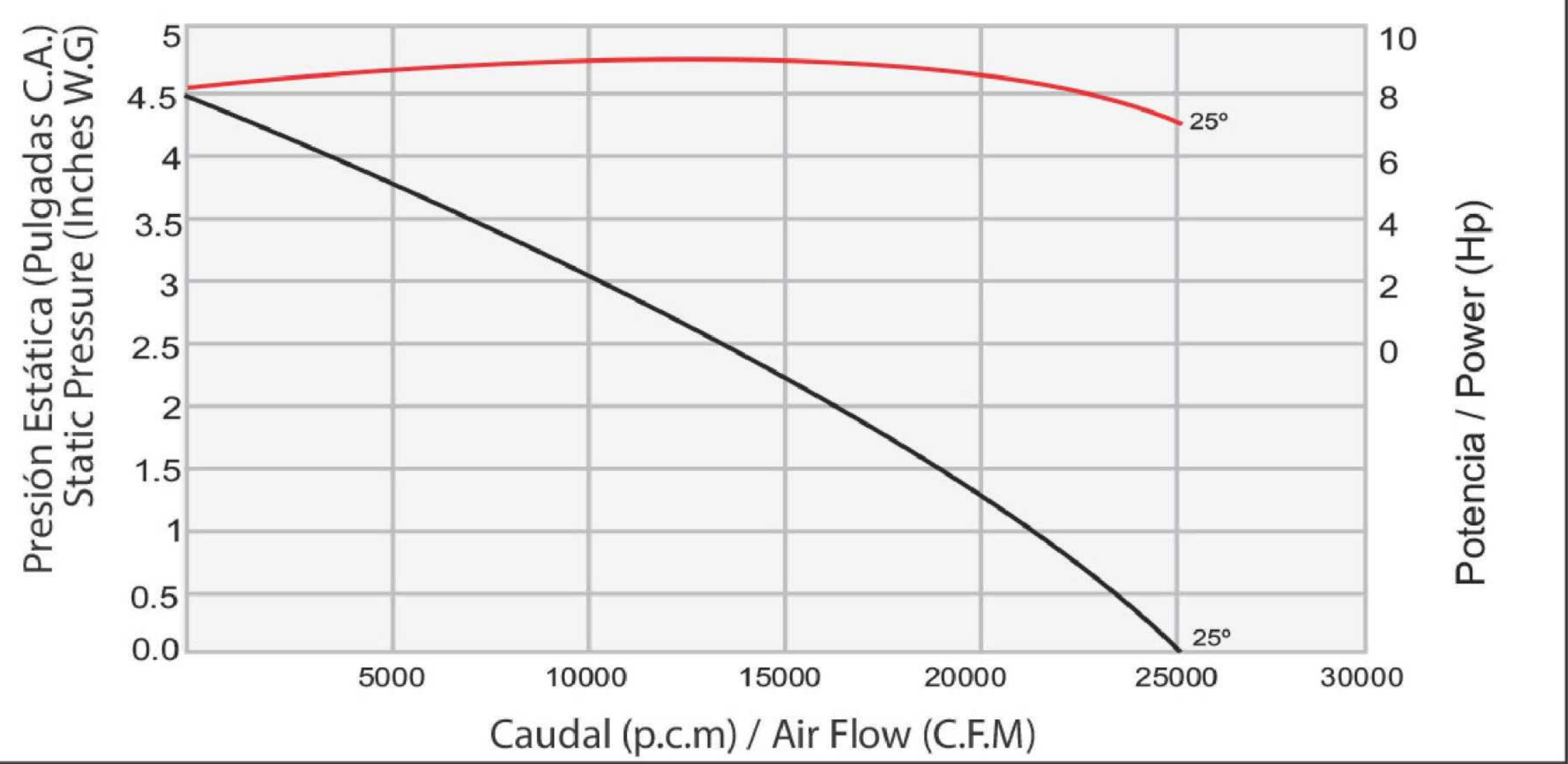

RUD-30 6 POLOS

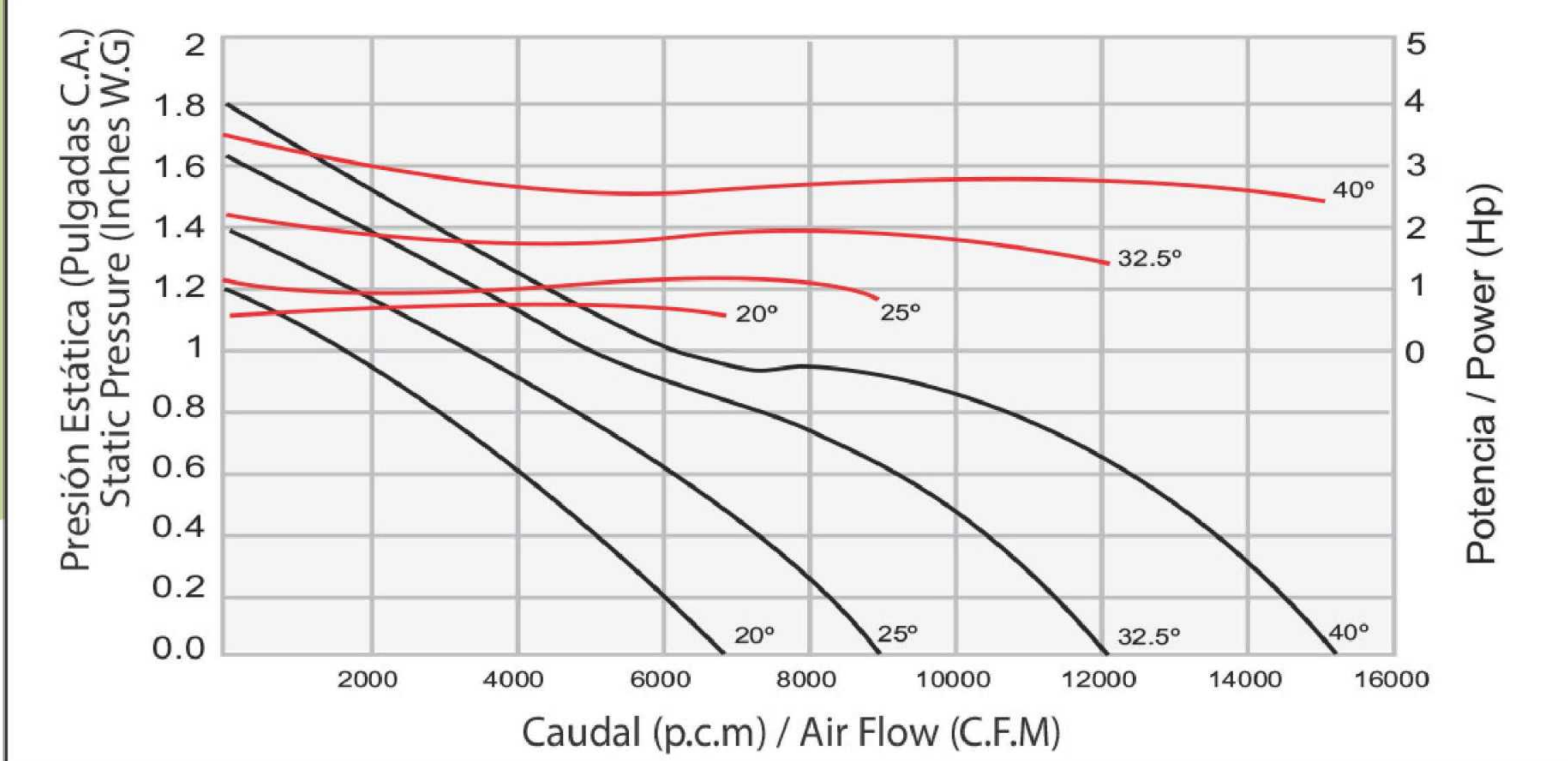

RUD-42 6 POLOS

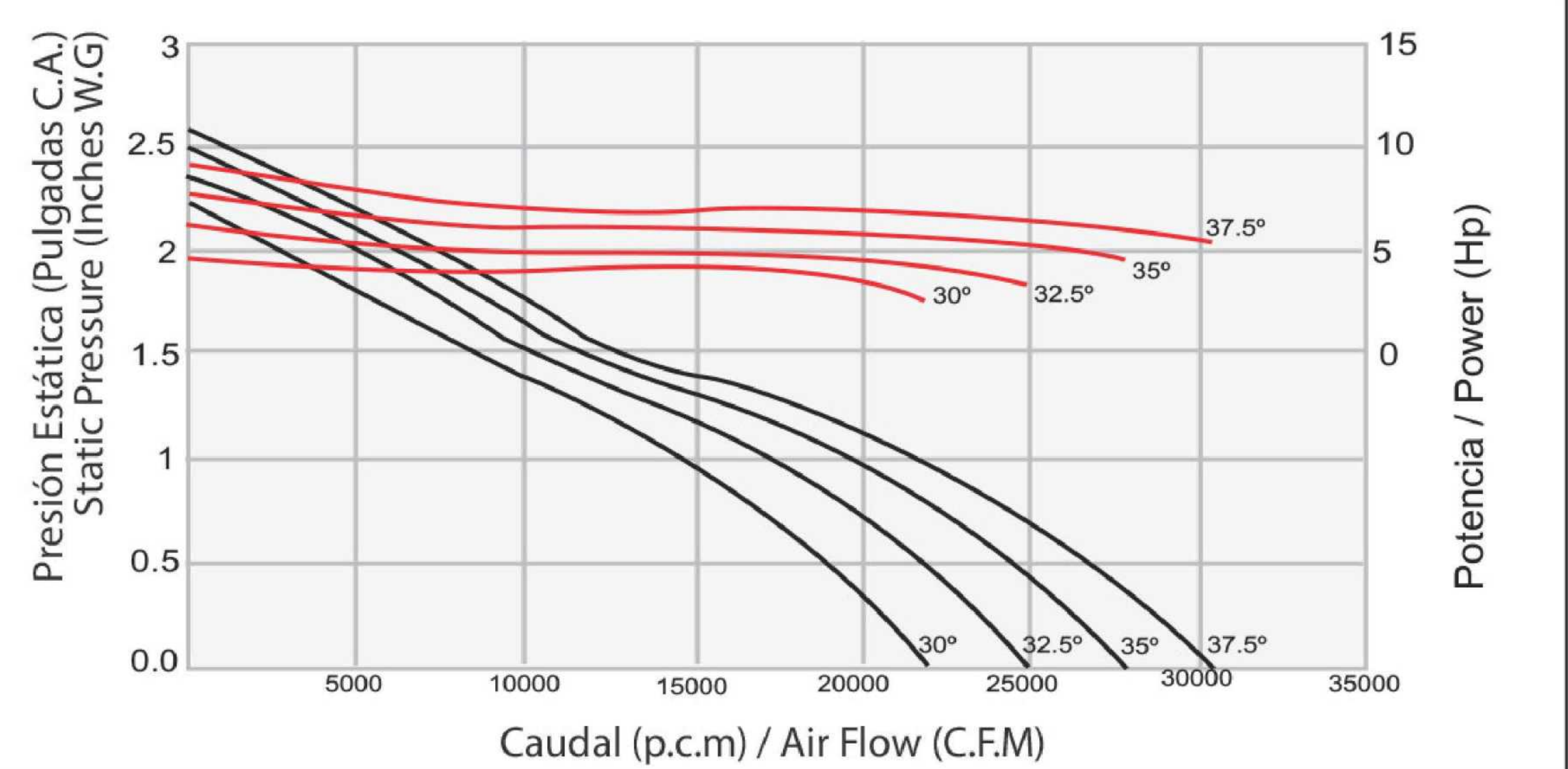

RUD-36 4 POLOS

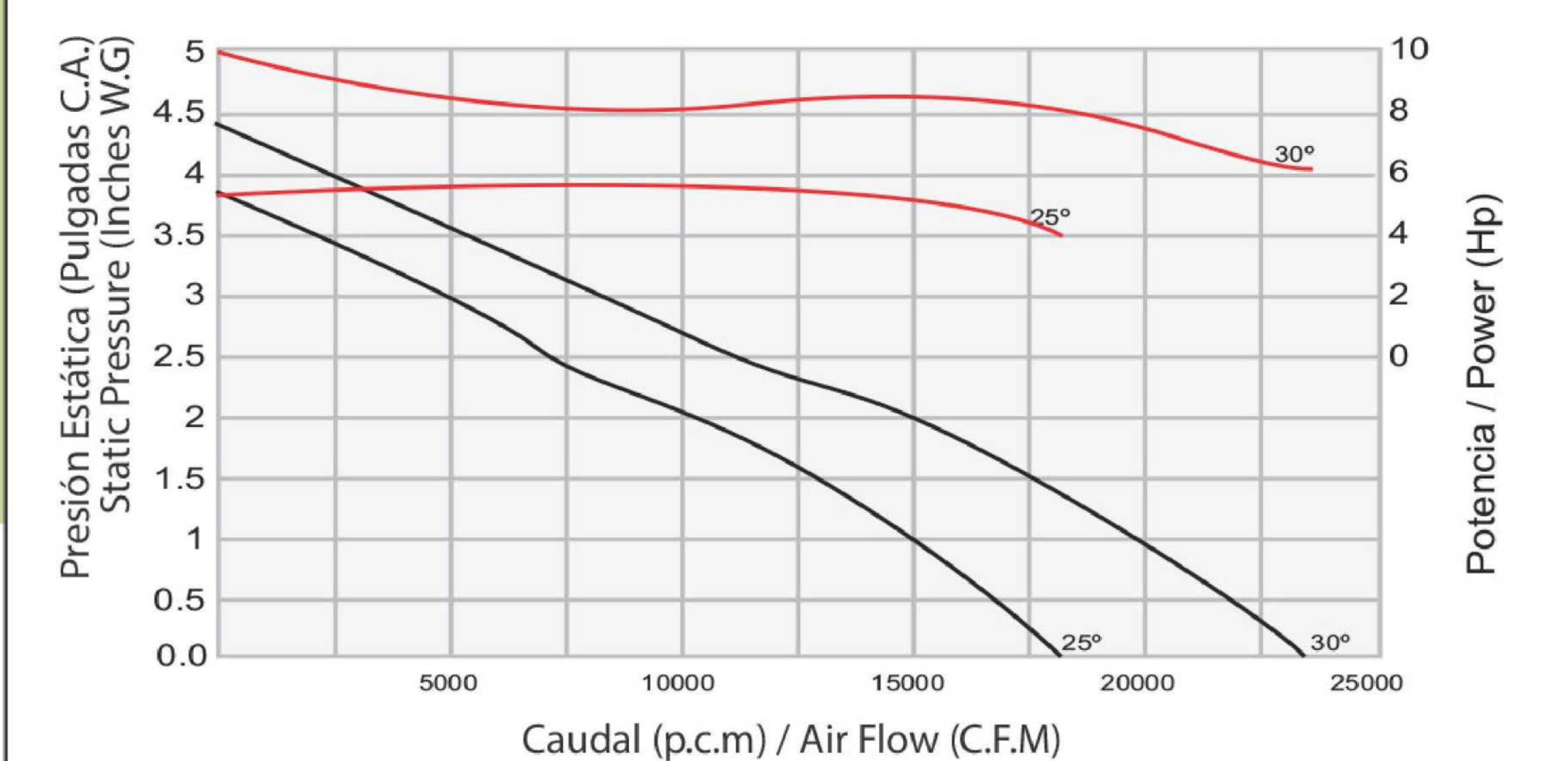

RUD-42 8 POLOS

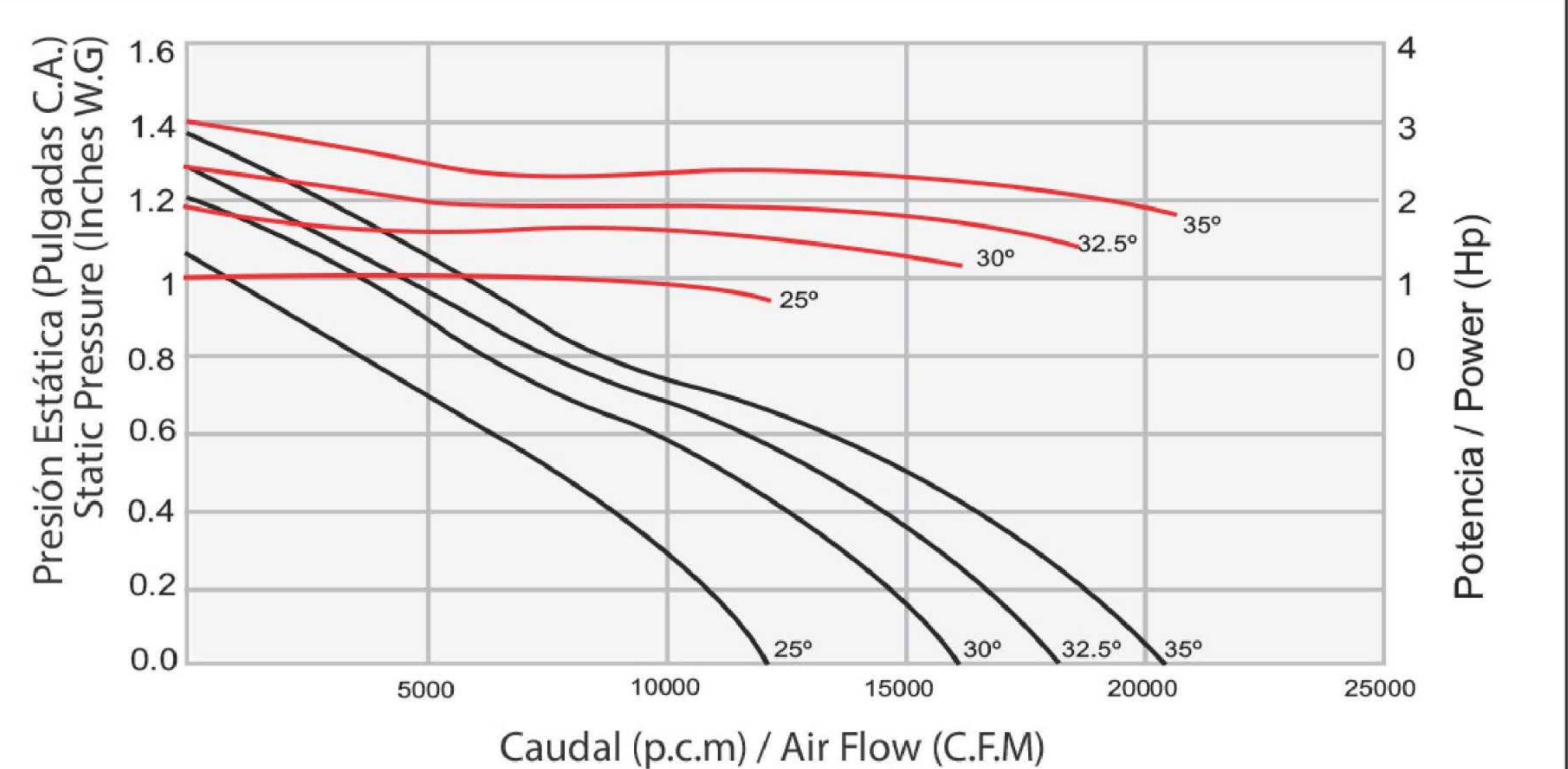

Aero extractores axiales de techo ATC línea Butterfly. Acoplamiento Directo.
 ATC Axial upblast roof exhaust fans butterfly series. Direct Drive.

Especificaciones técnicas / Performance data

MODELO MODEL	CAUDAL @ DESCARGA LIBRE AIR FLOW		AMPERAJE (A) CURRENT (A)		POTENCIA POWER (HP)	VENTILADOR RPM FAN RPM	NIVEL SONORO SOUND LEVEL dB (A)*	PESO APROX. APPROXIMATE WEIGHT	
			3 FASES @ 60 HZ 3 PHASE @ 60 HZ					Lb.	Kg.
	CFM	M3/HR	220 V	440V					
TUB-P/A-24/25°	5,890	10,007	3.0	1.5	3/4	1300	62	110	50
TUB-P/A-24/30°	7,130	12,114	4.0	2.0	1	1300	66	114	52
TUB-P/A-24/35°	8,410	14,289	5.2	2.6	1.5	1300	70	128	58
TUB-P/A-24/40°	9,460	16,073	6.6	3.3	2	1300	72	136	62
TUB-P/A-24/40°	10,300	17,500	9.8	4.9	3	1300	74	163	74
TUB-P/A-30/20°	7,800	13,252	4.0	2.0	1	1300	67	143	65
TUB-P/A-30/25°	10,100	17,160	5.2	2.6	1.5	1300	72	156	71
TUB-P/A-30/30°	12,400	21,068	6.6	3.3	2	1300	76	165	75
TUB-P/A-30/32.5°	13,700	23,276	9.8	4.9	3	1300	79	191	87
TUB-P/A-30/35°	15,000	24,485	9.8	4.9	3	1300	81	191	87
TUB-P/A-30/37.5°	16,100	27,354	15.0	7.5	5	1300	82	209	95
TUB-P/A-30/40°	17,200	29,223	15.0	7.5	5	1300	83	209	95
TUB-P/A-30/40°	19,400	32,961	15.0	7.5	5	1300	86	209	95
TUB-P/A-36/25°	13,500	22,937	6.6	3.3	2	1300	66	209	95
TUB-P/A-36/30°	17,400	29,563	9.8	4.9	3	1300	72	235	107
TUB-P/A-36/35°	21,600	36,698	15.0	7.5	5	1300	76	253	115
TUB-P/A-36/37.5°	23,500	39,927	15.0	7.5	5	1300	78	253	115
TUB-P/A-36/40°	25,400	43,155	23.0	11.5	7.5	1300	80	290	132
TUB-P/A-42/30°	21,000	35,679	15.0	7.5	5	1300	76	295	134
TUB-P/A-42/32.5°	23,900	40,606	15.0	7.5	5	1300	79	295	134
TUB-P/A-42/35°	26,800	45,533	15.0	7.5	5	1300	81	295	134
TUB-P/A-42/37.5°	29,100	49,441	23.0	11.5	7.5	1300	83	332	151
TUB-P/A-42/40°	31,400	53,349	23.0	11.5	7.5	1300	85	332	151
TUB-P/A-48/30°	22,700	38,567	6.6	3.3	2.0	550	74	321	146
TUB-P/A-48/36°	27,100	40,043	6.6	3.3	2.0	550	74	321	146
TUB-P/A-48/43°	32,000	54,368	9.8	4.9	3.0	550	78	348	158
TUB-P/A-48/48°	35,200	59,805	15.0	7.5	5.0	550	79	370	168
TUB-P-54/30°	31,400	53,349	9.8	4.9	3.0	550	70	387	176
TUB-P-54/36°	38,300	65,072	15.0	7.5	5.0	550	75	409	186
TUB-P-54/43°	45,000	76,455	23.0	11.5	7.5	550	78	466	212
TUB-P-54/48°	48,900	83,081	26.0	13.0	10.0	550	80	486	221
TUB-P-60/30°	38,600	65,581	9.8	4.9	3.0	550	77	398	181
TUB-P-60/36°	47,500	80,702	15.0	7.5	5.0	550	82	418	190
TUB-P-60/43°	57,500	97,692	23.0	11.5	7.5	550	86	477	217
TUB-P-60/48°	63,000	107,037	26.0	13.0	10.0	550	88	497	226

* Nivel sonoro medido a 1.50 metros (5 pies) de la fuente en un campo hemisférico libre según AMCA Standar 301.

Sound pressure measured in a free field with 1/2 spherical propagation at a distance of 1.5 meters (5 feet) from the source according to AMCA Standard 301.

** L: RPM Baja-Low RPM / M: RPM Media-Medium RPM / H: RPM Alta-High RPM

Curvas de operación / Performance curves

TUB-24

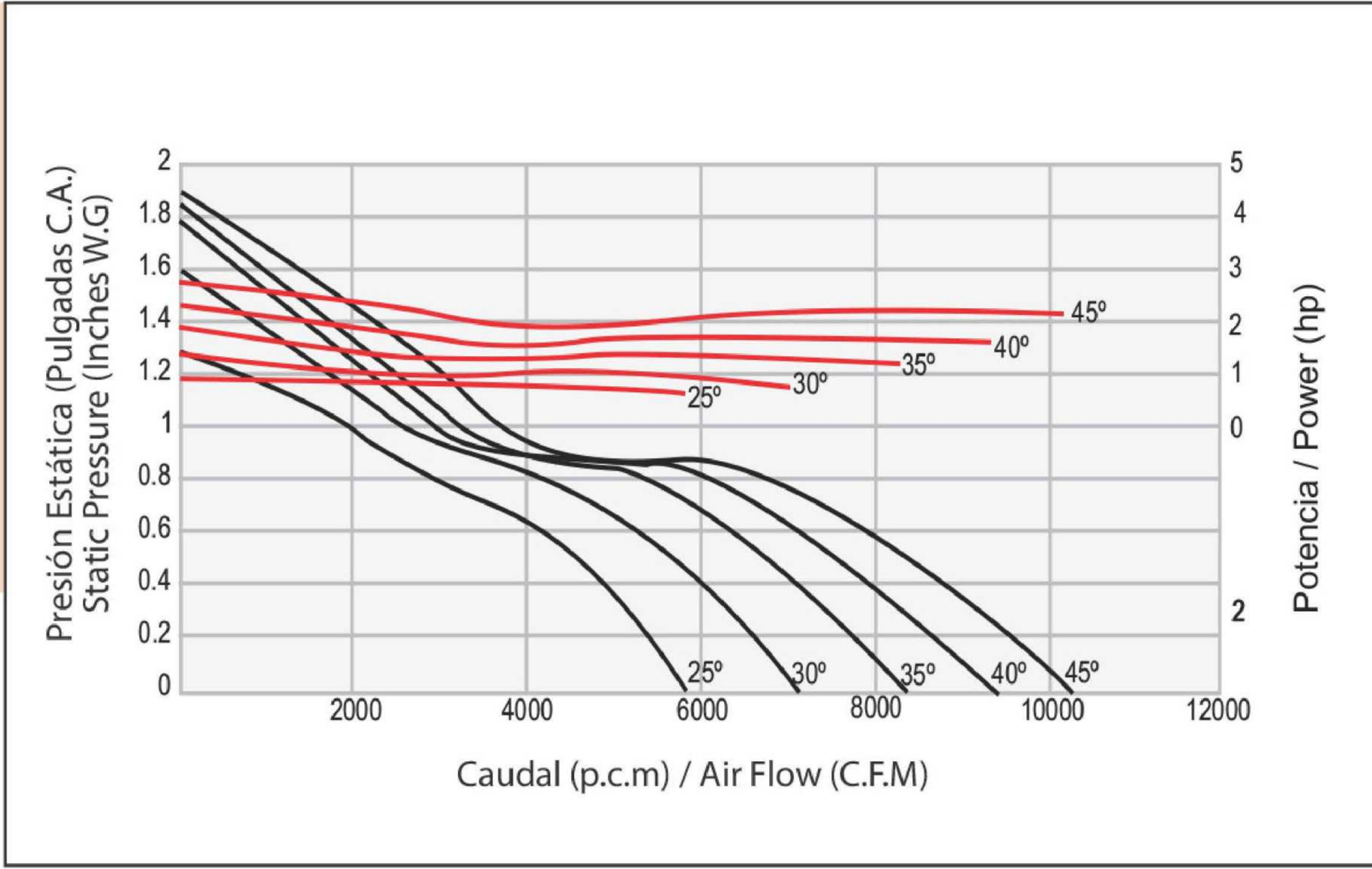

TUB-48

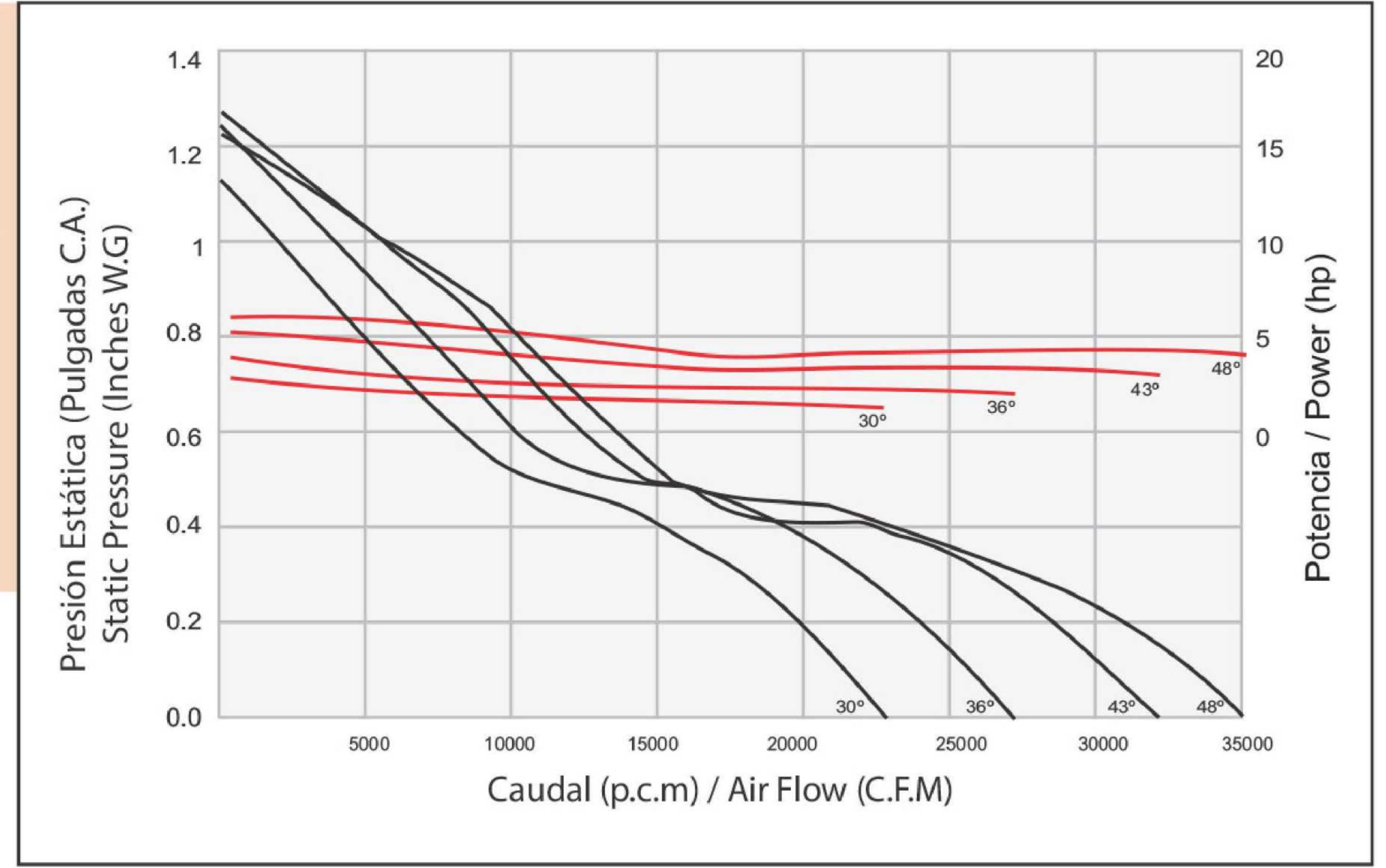

TUB-30

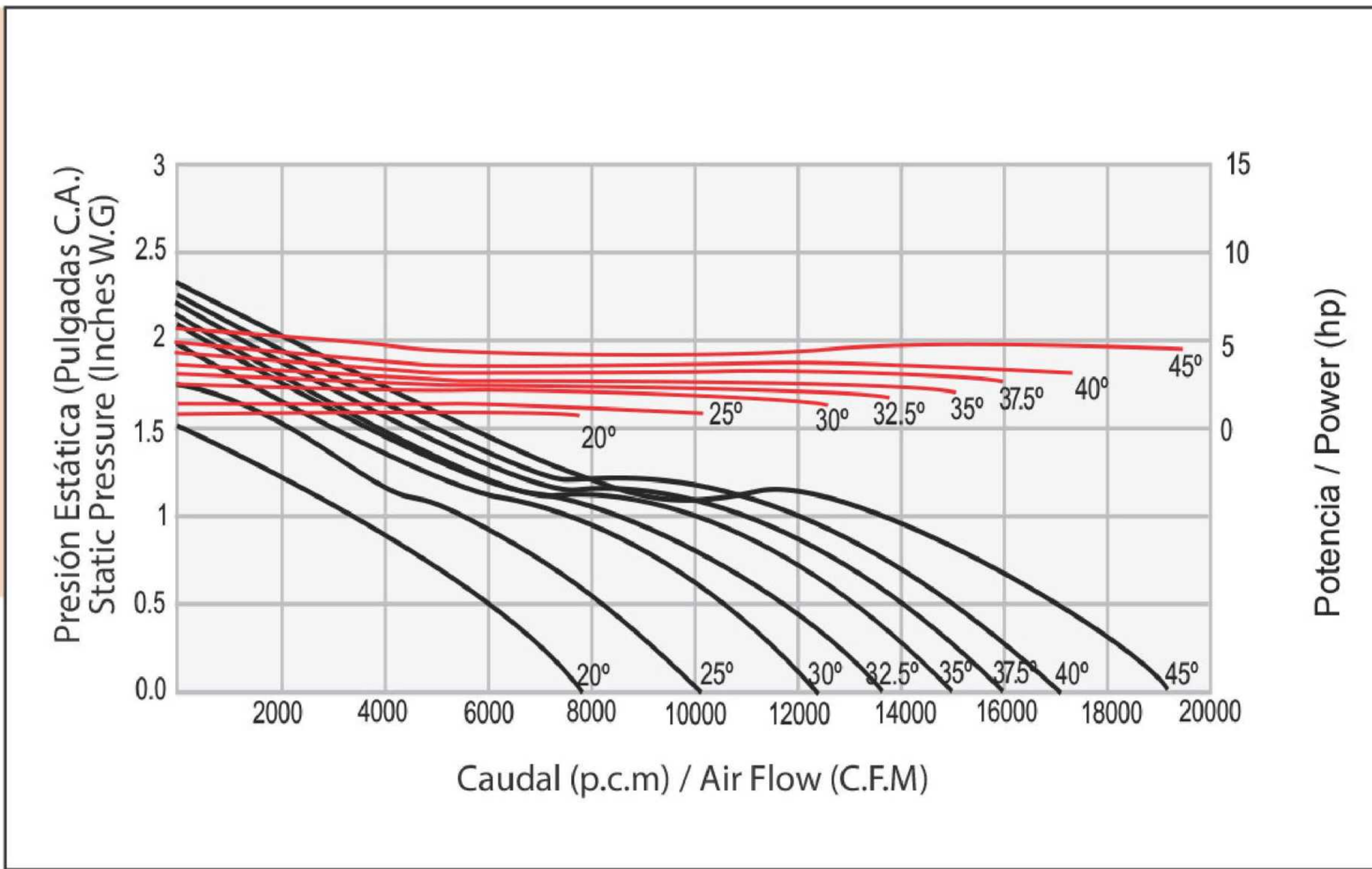

TUB-54

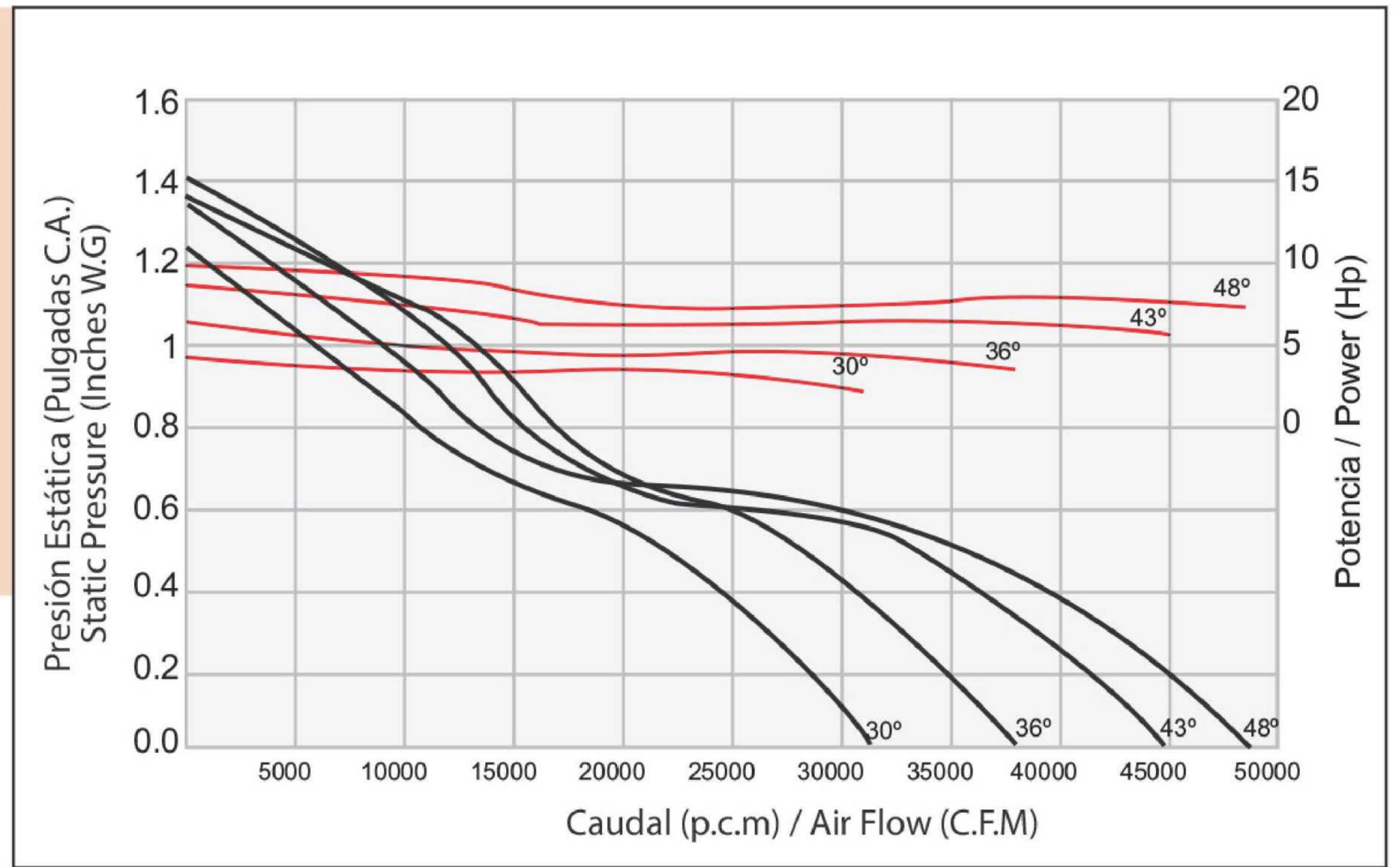

TUB-36

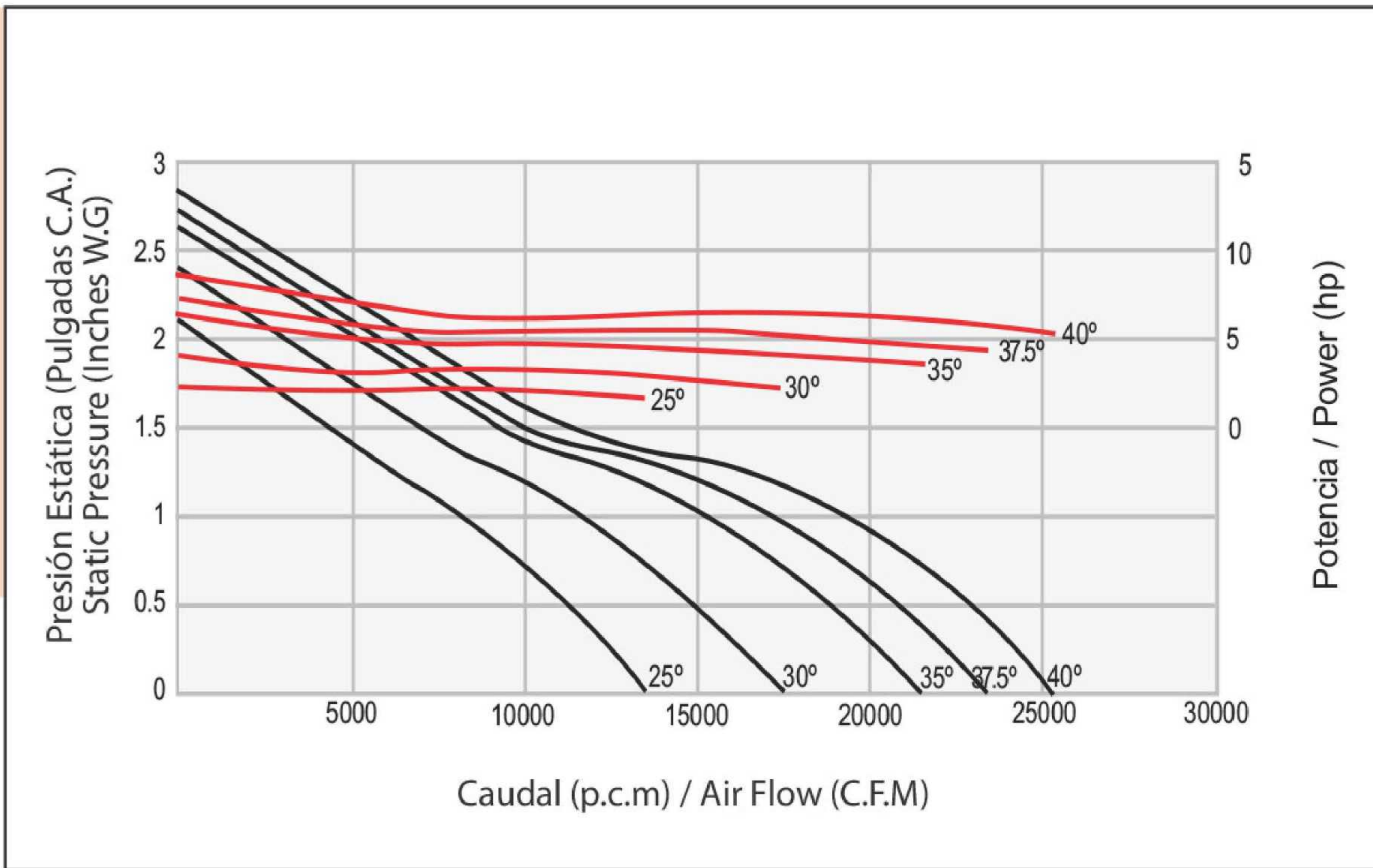

TUB-60

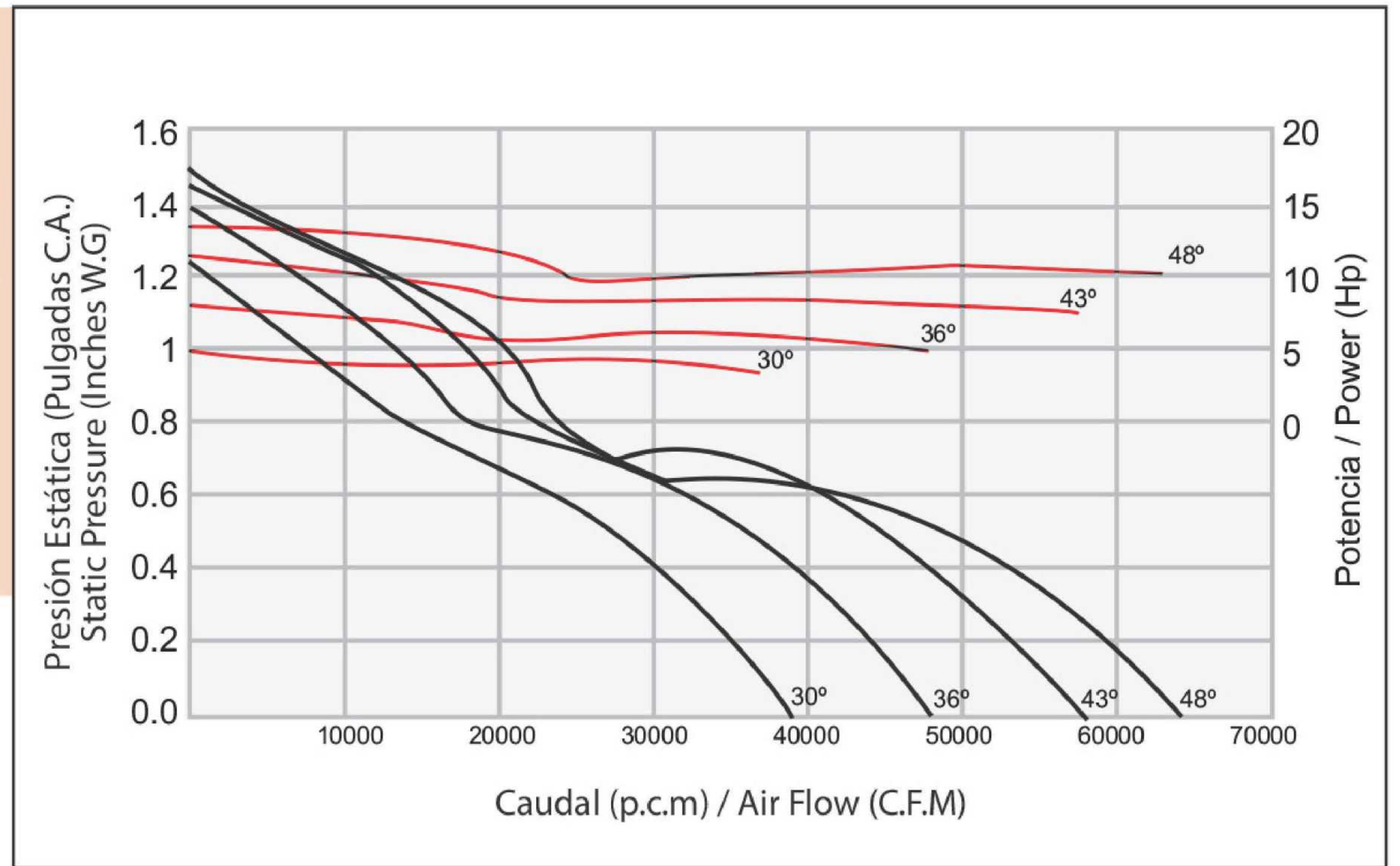

TUB-42

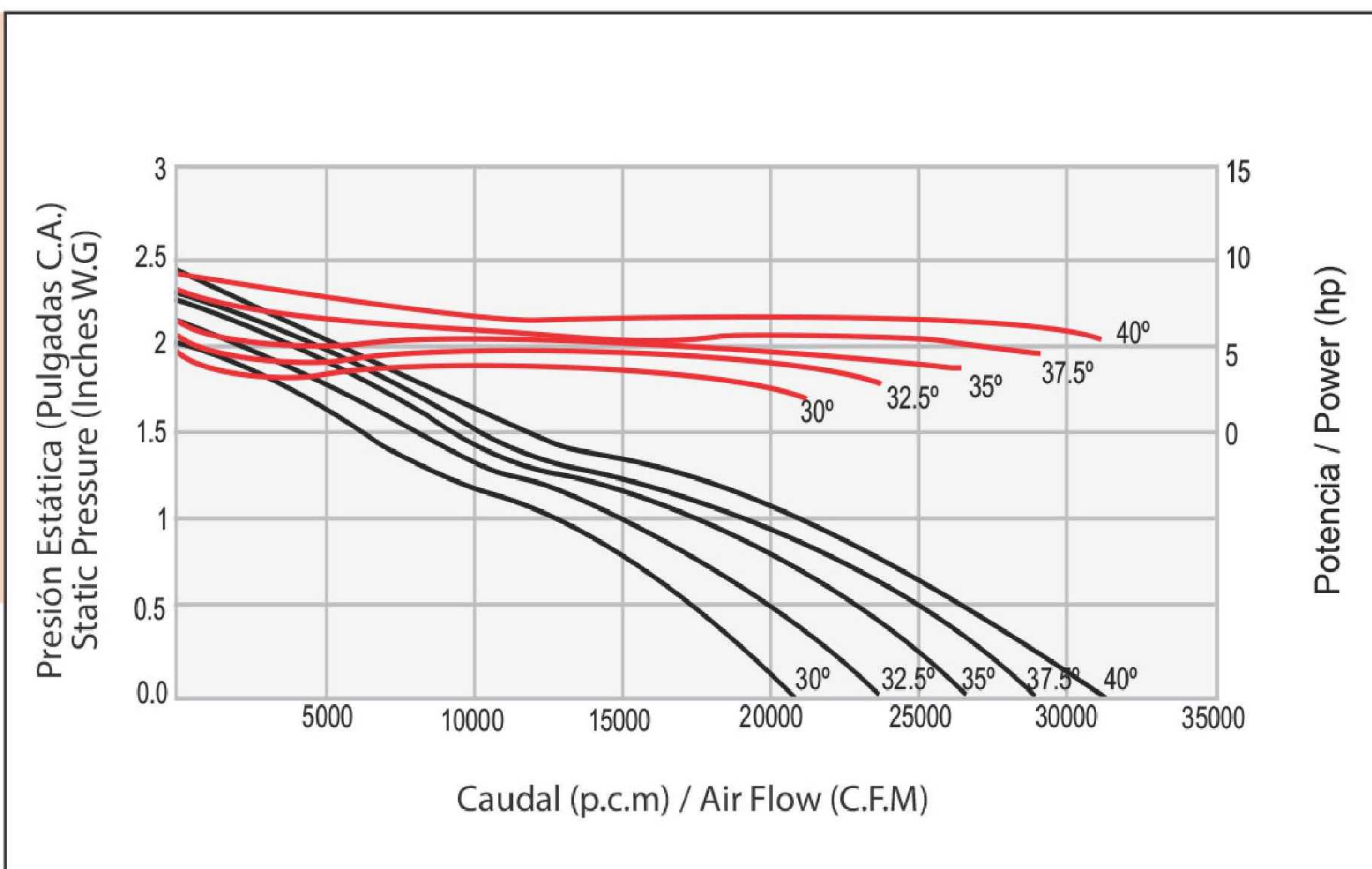

Aero extractores axiales de techo ATC con transmisión de poleas y bandas, línea Butterfly.
 ATC Belt Drive Axial upblast roof exhaust fans, butterfly series.

Dimensiones generales / Dimensions

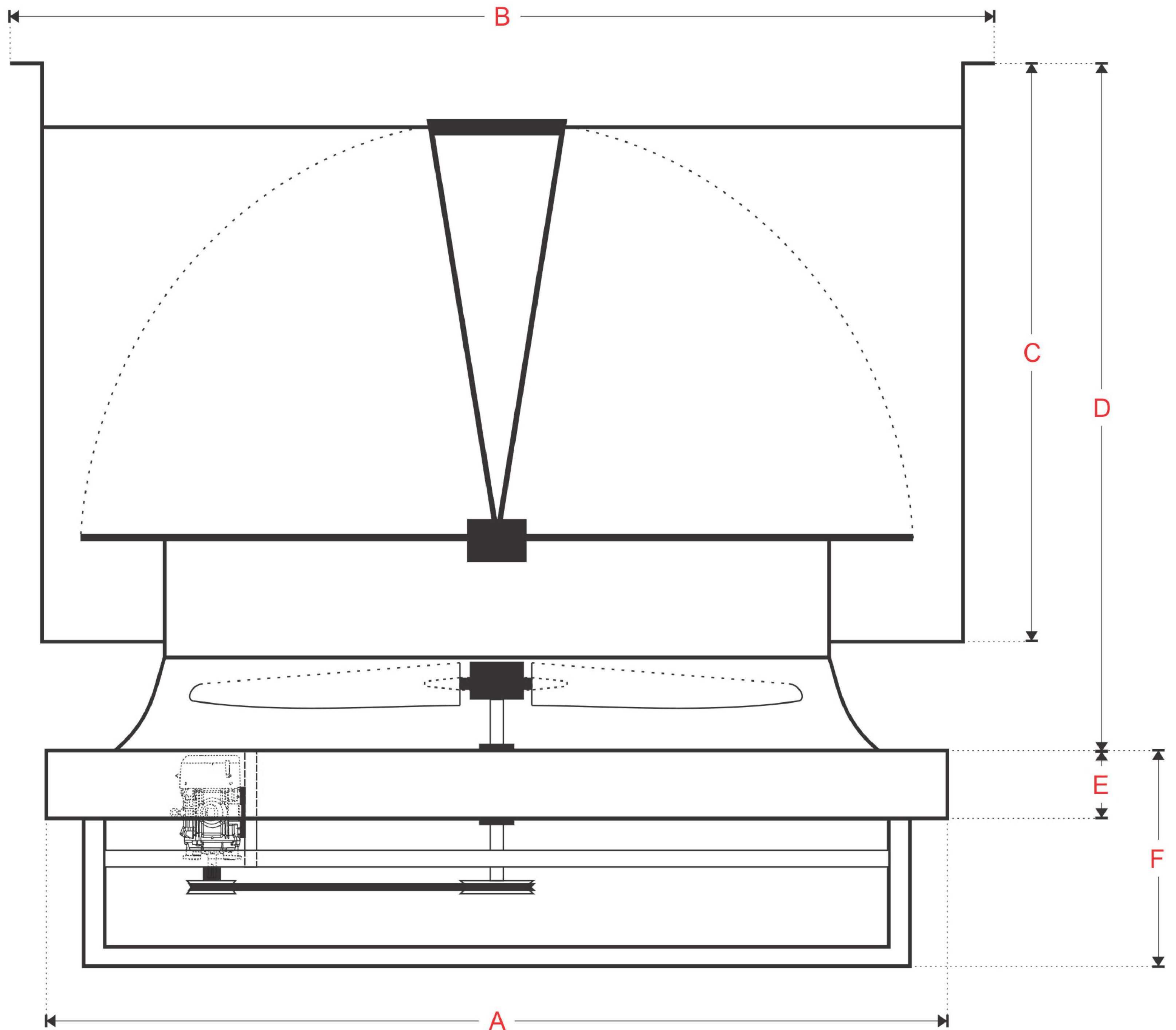

Modelo / Model	Pulgadas / Inches					
	A	B	C	D	E	F
RUB-24	30	32	16 1/2	21	2 3/4	14
RUB-30	36	38	19 1/2	24	2 3/4	14
RUB-36	42	44	22 1/2	27	2 3/4	14
RUB-42	48	50	25 1/2	30	2 3/4	16
RUB-48	54	56	28 1/2	33	2 3/4	16
RUB-54	62	64	32 1/2	38	2 3/4	23 1/4
RUB-60	68	70	35 1/2	41	2 3/4	23 1/4

Aero extractores axiales de techo ATC en Acoplamiento Directo, línea Butterfly.
 ATC Direct Drive axial upblast roof exhaust fan. Butterfly series.

Dimensiones generales / Dimensions

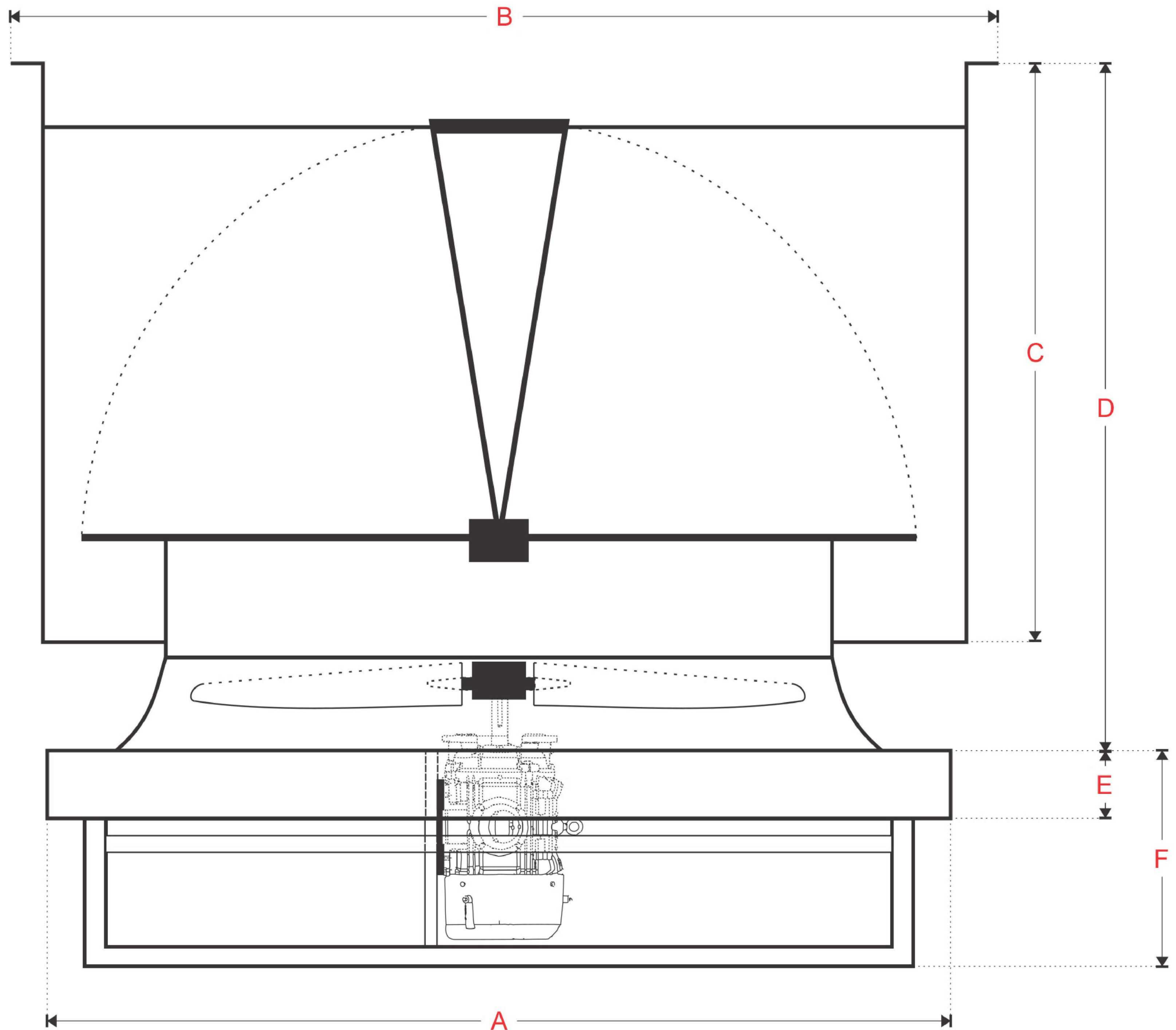

Modelo / Model	Pulgadas / Inches					
	A	B	C	D	E	F
RUD-24	30	32	16 1/2	21	2 3/4	14
RUD-30	36	38	19 1/2	24	2 3/4	14
RUD-36	42	44	22 1/2	27	2 3/4	16
RUD-42	48	50	25 1/2	30	2 3/4	16

Aero extractores tubo axiales de techo ATC con transmisión de poleas y bandas, línea Butterfly.
 ATC Belt Drive Axial upblast roof exhaust fans, butterfly series.

Dimensiones generales / Dimensions

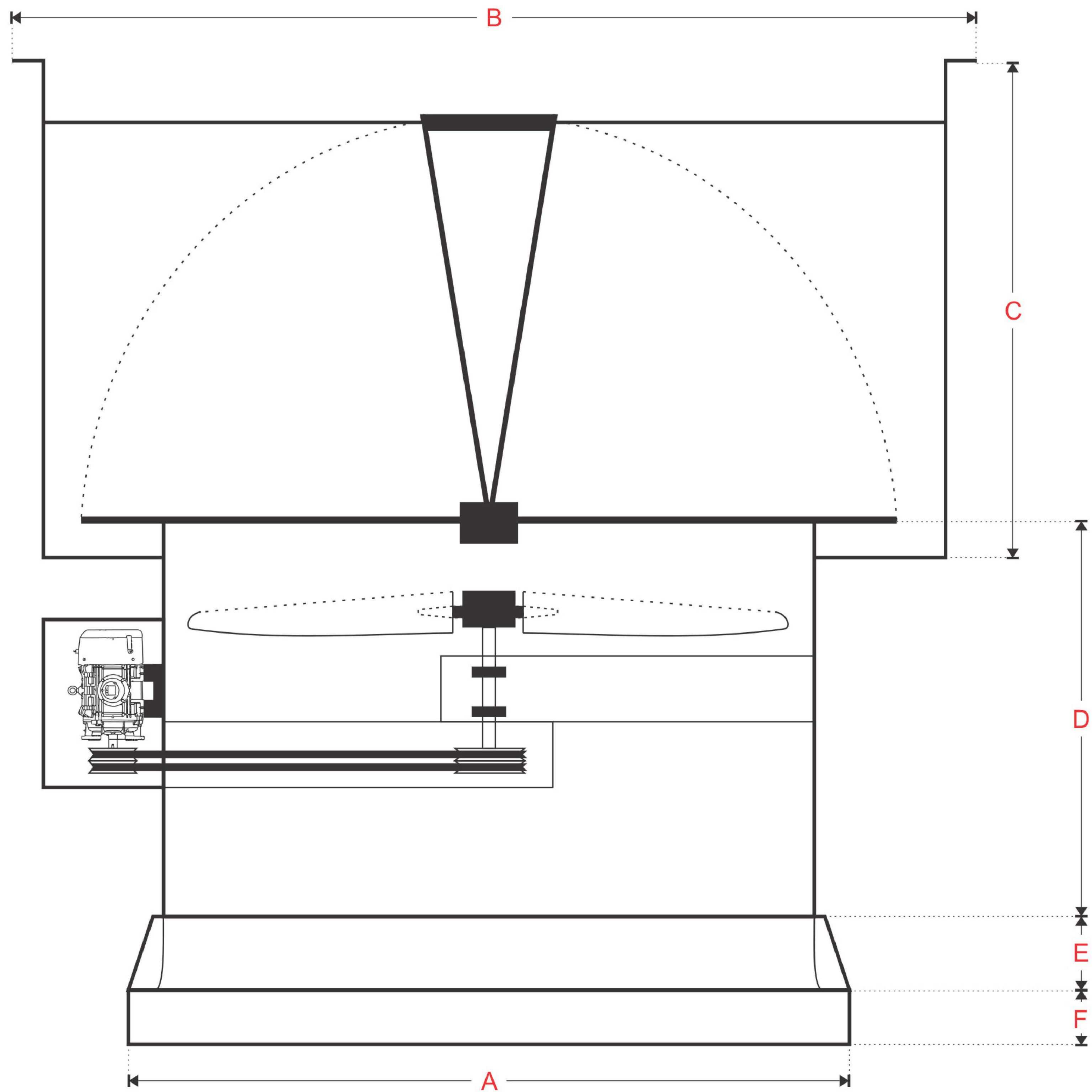

Modelo / Model	Pulgadas / Inches					
	A	B	C	D	E	F
TUB-24	30	32	16 1/2	22 1/2	2 3/4	4 1/2
TUB-30	36	39	19 1/2	22 1/2	2 3/4	4 1/2
TUB-36	42	45	22 1/2	30	2 3/4	4 1/2
TUB-42	48	51	25 1/2	30	2 3/4	4 1/2
TUB-48	54	57	28 1/2	34	2 3/4	4 1/2
TUB-54	62	64	32 1/2	38	2 3/4	5 1/2
TUB-60	68	70	35 1/2	38	2 3/4	5 1/2



The Right Choice

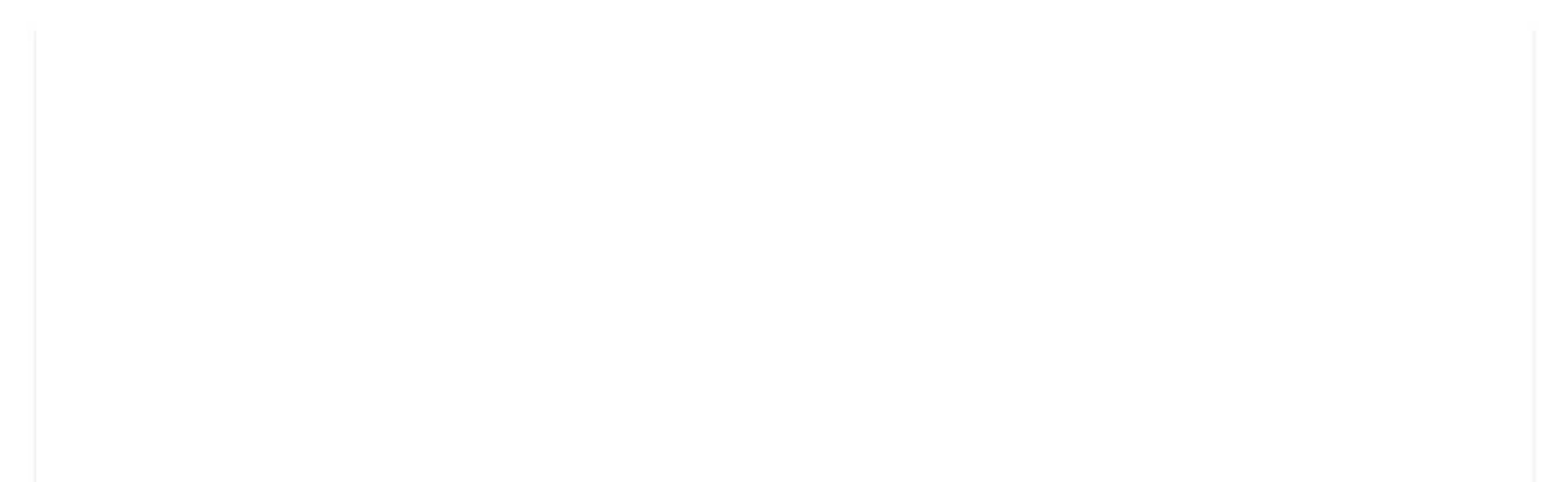

MOMC

ELECTRIC

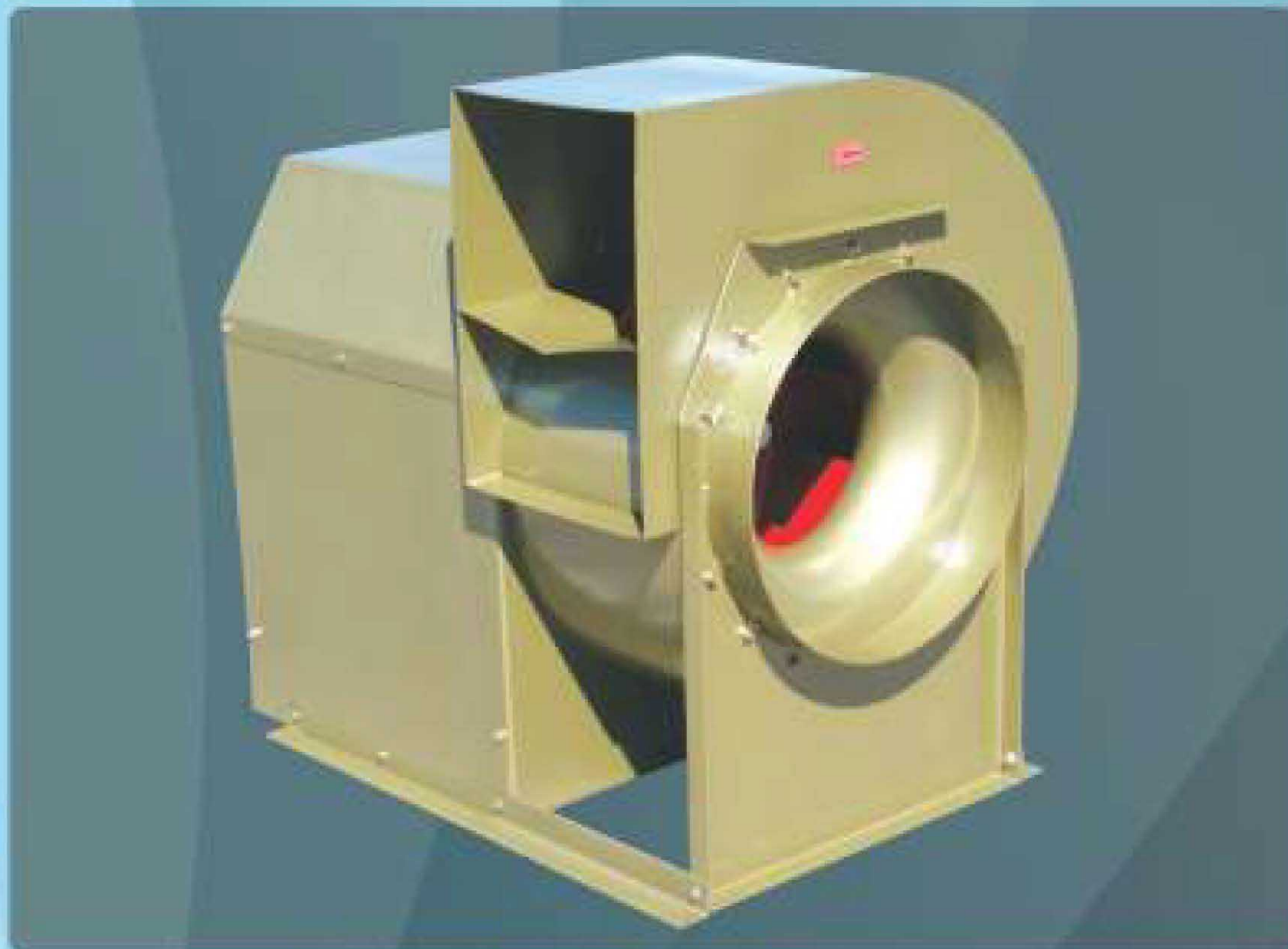

OFICINAS
Santiago de Querétaro,
Querétaro, México.

CONTACTO

442 219 7860
442 721 34 12
442 106 35 73

info@extractoresindustrialesdeaire.com